

CATALOG | JUNE 2018

# **Low voltage** General performance motors

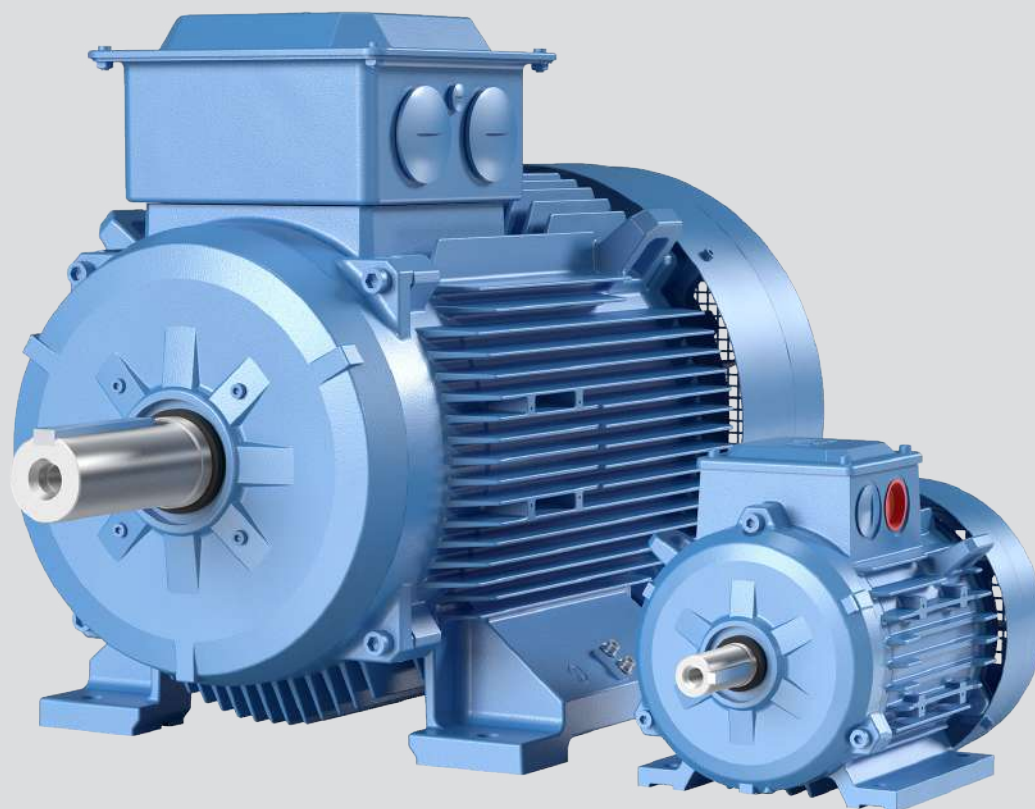

---

**With expertise, and a comprehensive portfolio of products and life-cycle services, we help value-minded industrial customers improve their energy efficiency and productivity.**

# Low voltage General performance motors

Sizes 56 to 355, 0.06 to 355 kW

<b>4</b>	<b>General information</b>
7	Mounting arrangements
8	Cooling
9	Degrees of protection: IP code/IK code
10	Insulation
11	Voltage and frequency
<b>14</b>	<b>Cast iron motors IE3 and IE2 M2BAX</b>
14	Ordering information
15	Rating plates
16	Technical data IE2 and IE3
22	Variant codes
24	Mechanical design
30	Dimension drawings
31	Dimension drawings
33	Motors in brief
<b>38</b>	<b>Aluminum motors</b>
38	Ordering information
39	Technical data
45	Variant codes
47	Dimension drawings
48	Motors in brief
<b>50</b>	<b>Total product offering</b>
<b>51</b>	<b>ABB's portfolio of drives</b>

# International motor efficiency standards and regulations

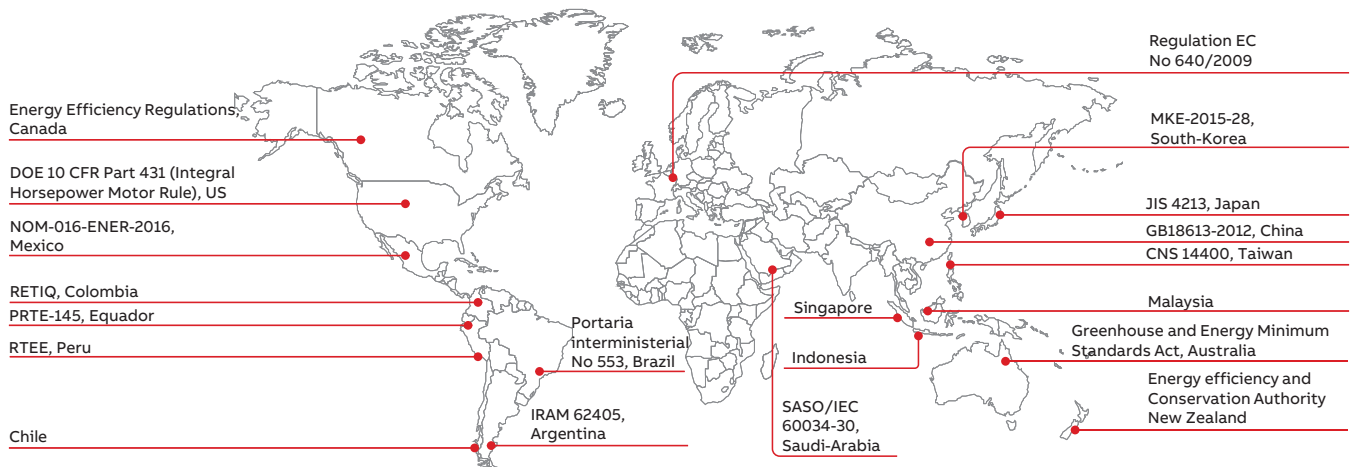

Since the validation of IEC 60034-30:2008 and its refined version IEC 60034-30-1:2014, a worldwide energy efficiency classification system has existed for low voltage three-phase asynchronous motors. These international standards have been created to enable and increase the level of harmonization in efficiency regulations around the world and to also cover motors for explosive atmospheres.

IEC 60034-30-1:2014 defines International Efficiency (IE) classes for single speed, three-phase, 50 Hz and 60 Hz induction motors. The efficiency levels defined in IEC 60034-30-1 are based on the test method specified in IEC 60034-2-1:2014. Both standards are part of an effort to unify motor testing procedures with CSA390-10 and IEEE 112 standards as well as efficiency and product labeling (IE) requirements to enable motor purchasers worldwide to easily recognize premium efficiency products.

To promote transparency in the market, IEC 60034-30-1 states that both the efficiency class and efficiency value must be shown on the motor rating plate and in product documentation. The documentation must clearly indicate the efficiency testing method used as different methods can produce differing results.

## Minimum energy performance standards

While the IEC as an international standardization organization sets guidelines for motor testing and efficiency classes, the organization does not regulate efficiency levels in countries. The biggest drivers for mandatory Minimum Energy Performance Standard (MEPS) levels for electric motors are global climate change, government targets to curb CO<sub>2</sub> emissions and rising electricity demand, especially in developing countries. The whole value chain, from manufacturer up to end user, must be aware of the legislation in order to meet local requirements, to save energy and reduce the carbon footprint.

Harmonized global standards and the increasing adoption of MEPS around the world are good news for all of us. However, it is important to remember that harmonization is an ongoing process. Even though MEPS are already in effect in several regions and countries, they are evolving and differ in terms of scope and requirements. At the same time, more countries are planning to adopt their own MEPS regulations. A view of existing and coming MEPS regulations in the world can be seen on the World map above.

To get the latest information please visit [www.abb.com/motors&generators/energyefficiency](http://www.abb.com/motors&generators/energyefficiency).

### IEC 60034-30-1:2014

This standard defines four International Efficiency (IE) classes for single speed electric motors that are rated according to IEC 60034-1 or IEC 60079-0 (explosive atmospheres) and designed for operation on sinusoidal voltage.

- IE4 = Super premium efficiency
- IE3 = Premium efficiency, identical to the table in 10CFR431 ('NEMA Premium') in the USA and CSA C390-10:2015 for 60 Hz
- IE2 = High efficiency
- IE1 = Standard efficiency

IEC 60034-30-1 covers the power range from 0.12 kW up to 1000 kW. Most of the different technical constructions of electric motors are covered as long as they are rated for direct on-line operation. The coverage of the standard includes:

- Single speed electric motors (single and three-phase), 50 and 60 Hz
- 2, 4, 6 and 8 poles
- Rated output  $P_N$  from 0.12 kW to 1000 kW
- Rated voltage  $U_N$  above 50 V up to 1 kV
- Motors capable of continuous operation at their rated power with a temperature rise within the specified insulation temperature class
- Motors, marked with any ambient temperature within the range of -20 °C to +60 °C
- Motors, marked with an altitude up to 4000 m above sea level

By comparing IEC 60034-30-1 to CSA C390-10:2015 and "10CFR431 Subpart B – Electric motors", it can be seen that the efficiency limits and tables are well aligned and their major difference is in the scope of the output power where CSA and 10CFR431 have a maximum power of 500 hp. There are also some minor differences in the scope of excluded motors.

Note: CFR is Code of Federal Regulations.

The following motors are excluded from IEC 60034-30-1:

- Single-speed motors with 10 or more poles or multi-speed motors
- Motors completely integrated into a machine (for example pump, fan or compressor) that cannot be tested separately from the machine
- Brake motors, when the brake cannot be dismantled or separately fed

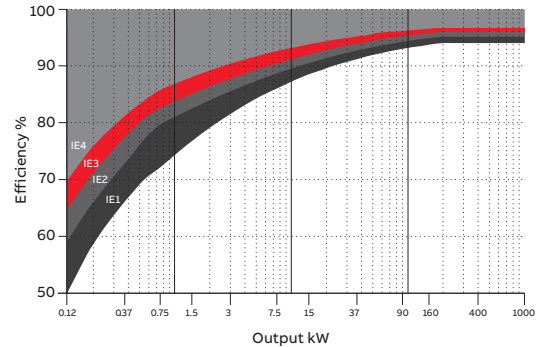

01

### ABB and efficiency standards

ABB determines efficiency values according to IEC 60034-2-1 using the low uncertainty method (i.e. summation of losses), with additional load losses determined by the method of residual loss.

It is good to mention and emphasize that the IEC 60034-2-1 test method, which is known as an indirect method, is technically equivalent to the test methods in the standards CSA 390-10 and IEEE 112 Method B leading to the equivalent losses and thus efficiency values. Both test methods can be used by ABB and shall be used for both Canada and the US where IEC 60034-2-1 is not recognized yet.

As the world market leader, ABB offers the largest range of LV motors available. It has long advocated the need for efficiency in motors, and high efficiency products have formed the core of its portfolio for many years. The core of ABB's Process performance range is based on a full range of IE2 and IE3 motors - with many available from stock. We also supply IE4 motors for additional energy savings.

**Nominal efficiency limits defined in IEC  
60034-30-1:2014 (reference values at 50 Hz,  
based on test methods specified in IEC 60034-  
2-1:2014).**

Out-put kW	IE1 Standard efficiency				IE2 High efficiency				IE3 Premium efficiency				IE4 Super Premium efficiency			
	2 pole	4 pole	6 pole	8 pole	2 pole	4 pole	6 pole	8 pole	2 pole	4 pole	6 pole	8 pole	2 pole	4 pole	6 pole	8 pole
0.12	45.0	50.0	38.3	31.0	53.6	59.1	50.6	39.8	60.8	64.8	57.7	50.7	66.5	69.8	64.9	62.3
0.18	52.8	57.0	45.5	38.0	60.4	64.7	56.6	45.9	65.9	69.9	63.9	58.7	70.8	74.7	70.1	67.2
0.20	54.6	58.5	47.6	39.7	61.9	65.9	58.2	47.4	67.2	71.1	65.4	60.6	71.9	75.8	71.4	68.4
0.25	58.2	61.5	52.1	43.4	64.8	68.5	61.6	50.6	69.7	73.5	68.6	64.1	74.3	77.9	74.1	70.8
0.37	63.9	66.0	59.7	49.7	69.5	72.7	67.6	56.1	73.8	77.3	73.5	69.3	78.1	81.1	78.0	74.3
0.40	64.9	66.8	61.1	50.9	70.4	73.5	68.8	57.2	74.6	78.0	74.4	70.1	78.9	81.7	78.7	74.9
0.55	69.0	70.0	65.8	56.1	74.1	77.1	73.1	61.7	77.8	80.8	77.2	73.0	81.5	83.9	80.9	77.0
0.75	72.1	72.1	70.0	61.2	77.4	79.6	75.9	66.2	80.7	82.5	78.9	75.0	83.5	85.7	82.7	78.4
1.1	75.0	75.0	72.9	66.5	79.6	81.4	78.1	70.8	82.7	84.1	81.0	77.7	85.2	87.2	84.5	80.8
1.5	77.2	77.2	75.2	70.2	81.3	82.8	79.8	74.1	84.2	85.3	82.5	79.7	86.5	88.2	85.9	82.6
2.2	79.7	79.7	77.7	74.2	83.2	84.3	81.8	77.6	85.9	86.7	84.3	81.9	88.0	89.5	87.4	84.5
3	81.5	81.5	79.7	77.0	84.6	85.5	83.3	80.0	87.1	87.7	85.6	83.5	89.1	90.4	88.6	85.9
4	83.1	83.1	81.4	79.2	85.8	86.6	84.6	81.9	88.1	88.6	86.8	84.8	90.0	91.1	89.5	87.1
5.5	84.7	84.7	83.1	81.4	87.0	87.7	86.0	83.8	89.2	89.6	88.0	86.2	90.9	91.9	90.5	88.3
7.5	86.0	86.0	84.7	83.1	88.1	88.7	87.2	85.3	90.1	90.4	89.1	87.3	91.7	92.6	91.3	89.3
11	87.6	87.6	86.4	85.0	89.4	89.8	88.7	86.9	91.2	91.4	90.3	88.6	92.6	93.3	92.3	90.4
15	88.7	88.7	87.7	86.2	90.3	90.6	89.7	88.0	91.9	92.1	91.2	89.6	93.3	93.9	92.9	91.2
18.5	89.3	89.3	88.6	86.9	90.9	91.2	90.4	88.6	92.4	92.6	91.7	90.1	93.7	94.2	93.4	91.7
22	89.9	89.9	89.2	87.4	91.3	91.6	90.9	89.1	92.7	93.0	92.2	90.6	94.0	94.5	93.7	92.1
30	90.7	90.7	90.2	88.3	92.0	92.3	91.7	89.8	93.3	93.6	92.9	91.3	94.5	94.9	94.2	92.7
37	91.2	91.2	90.8	88.8	92.5	92.7	92.2	90.3	93.7	93.9	93.3	91.8	94.8	95.2	94.5	93.1
45	91.7	91.7	91.4	89.2	92.9	93.1	92.7	90.7	94.0	94.2	93.7	92.2	95.0	95.4	94.8	93.4
55	92.1	92.1	91.9	89.7	93.2	93.5	93.1	91.0	94.3	94.6	94.1	92.5	95.3	95.7	95.1	93.7
75	92.7	92.7	92.6	90.3	93.8	94.0	93.7	91.6	94.7	95.0	94.6	93.1	95.6	96.0	95.4	94.2
90	93.0	93.0	92.9	90.7	94.1	94.2	94.0	91.9	95.0	95.2	94.9	93.4	95.8	96.1	95.6	94.4
110	93.3	93.3	93.3	91.1	94.3	94.5	94.3	92.3	95.2	95.4	95.1	93.7	96.0	96.3	95.8	94.7
132	93.5	93.5	93.5	91.5	94.6	94.7	94.6	92.6	95.4	95.6	95.4	94.0	96.2	96.4	96.0	94.9
160	93.8	93.8	93.8	91.9	94.8	94.9	94.8	93.0	95.6	95.8	95.6	94.3	96.3	96.6	96.2	95.1
200	94.0	94.0	94.0	92.5	95.0	95.1	95.0	93.5	95.8	96.0	95.8	94.6	96.5	96.7	96.3	95.4
250	94.0	94.0	94.0	92.5	95.0	95.1	95.0	93.5	95.8	96.0	95.8	94.6	96.5	96.7	96.5	95.4
315	94.0	94.0	94.0	92.5	95.0	95.1	95.0	93.5	95.8	96.0	95.8	94.6	96.5	96.7	96.6	95.4
355	94.0	94.0	94.0	92.5	95.0	95.1	95.0	93.5	95.8	96.0	95.8	94.6	96.5	96.7	96.6	95.4
400	94.0	94.0	94.0	92.5	95.0	95.1	95.0	93.5	95.8	96.0	95.8	94.6	96.5	96.7	96.6	95.4
450	94.0	94.0	94.0	92.5	95.0	95.1	95.0	93.5	95.8	96.0	95.8	94.6	96.5	96.7	96.6	95.4
500-1000	94.0	94.0	94.0	92.5	95.0	95.1	95.0	93.5	95.8	96.0	95.8	94.6	96.5	96.7	96.6	95.4

# Mounting arrangements

## Foot-mounted motor

Code I / code II

Product code pos. 12

A: foot-mounted, term. box top  
R: foot-mounted, term. box RHS  
L: foot-mounted, term. box LHS

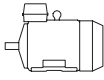
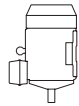
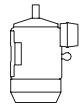
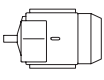
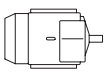
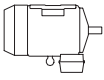
					
IM B3	IM V5	IM V6	IM B6	IM B7	IM B8
IM 1001	IM 1011	IM 1031	IM 1051	IM 1061	IM 1071

## Flange-mounted motor, large flange

Code I / code II

Product code pos. 12

B: flange mounted, large flange

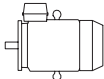
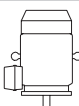
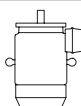
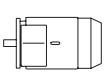
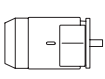
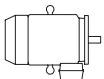
					
IM B5	IM V1	IM V3	*)	*)	*)
IM 3001	IM 3011	IM 3031	IM 3051	IM 3061	IM 3071

## Flange-mounted motor, small flange

Code I / code II

Product code pos. 12

C: flange mounted, small flange

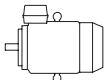
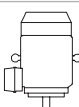
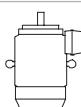
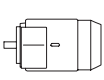
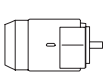
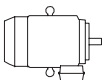
					
IM B14	IM V18	IM V19	*)	*)	*)
IM 3601	IM 3611	IM 3631	IM 3651	IM 3661	IM 3671

## Foot- and flange-mounted motor with feet, large flange

Code I / code II

Product code pos. 12

H: foot/flange-mounted, term. box top  
S: foot/flange-mounted, term. box RHS  
T: foot/flange-mounted, term. box LHS

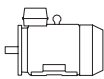
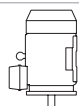
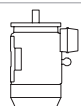
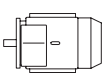
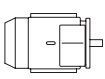
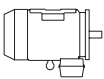
					
IM B35	IM V15	IM V35	*)	*)	*)
IM 2001	IM 2011	IM 2031	IM 2051	IM 2061	IM 2071

## Foot- and flange-mounted motor with feet, small flange

Code I / code II

Product code pos. 12

J: foot/flange-mounted, small flange

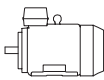
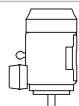
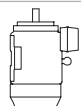
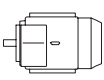
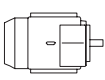
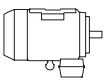
					
IM B34	IM V17		IM 2151	IM 2161	IM 2171
IM 2101	IM 2111	IM 2131	IM 2151	IM 2161	IM 2171

## Foot-mounted motor, shaft with free extensions

Code I / code II

Product code pos. 12

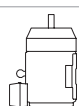
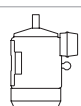
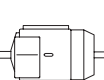
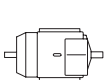
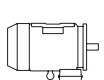
					
IM 1002	IM 1012	IM 1032	IM 1052	IM 1062	IM 1072

\*) Not stated in IEC 60034-7.

Note: If the motor is mounted shaft upwards, take measures to prevent water or any other liquid from running down the shaft into the motor.

# General information

## Cooling

Designation system concerning methods of cooling refers to standard IEC 60034-6.

### Explanation of the product code

International Cooling	Circuit arrangement	Primary coolant	Method of movement of primary coolant	Secondary coolant	Method of movement of secondary coolant
IC	4	(A)	1	(A)	6
	1	2	3	4	5

#### Position 1

0: Free circulation (open circuit)

4: Free circulation (open circuit)

#### Position 2

A: For air (omitted for simplified designation)

#### Position 3

0: Free convection

1: Self-circulation

6: Machine-mounted independent component

#### Position 4

A: For air (omitted for simplified designation)

W: For water

#### Position 5

0: Free convection

1: Self-circulation

6: Machine-mounted independent component

8: Relative displacement



# General information

## Degrees of protection: IP code/IK code

Classification of degrees of protection provided by enclosures of rotating machines are refers to:

- Standard IEC 60034-5 or EN 60529 for IP code
- Standard EN 50102 for IK code

### IP protection

Protection of persons against getting in contact with (or approaching) live parts and against contact with moving parts inside the enclosure. Also protection of the machine against ingress of solid foreign objects. Protection of machines against the harmful effects due to the ingress of water.

#### Explanation of the IP code

Ingress protection	Degree of protection to persons and to parts of the motors inside the enclosure	Degree of protection provided by the enclosure with respect to harmful effects due to ingress of water
IP	5	5
	1	2

#### Position 1

2:	Motors protected against solid objects greater than 12 mm
4:	Motors protected against solid objects greater than 1 mm
5:	Dust-protected motors
6:	Dust-tight motors

#### Position 2

3:	Motors protected against spraying water
4:	Motors protected against splashing water
5:	Motors protected against water jets
6:	Motors protected against heavy seas

### IK code

Classification of degrees of protection provided by enclosure for motors against external mechanical impacts.

#### Explanation of the IK code

International mechanical protection	Characteristic group
IK	08
	1

#### Position 1

##### Relation between IK code and impact energy:

IK code	Impact energy/Joule
0:	Not protected according to EN 50102
01:	0.15
02:	0.2
03:	0.35
04:	0.5
05:	0.7
06:	1
07:	2
08:	5 (ABB Standard)
09:	10
10:	20

# Insulation

01 Safety margins per thermal class.

ABB uses class F insulation, which, with temperature rise B, is the most common requirement among industry today.

The use of class F insulation with class B temperature rise gives ABB products a 25 °C safety margin. This can be used to increase the loading for limited periods, to operate at higher ambient temperatures or altitudes, or with greater voltage and frequency tolerances. It can also be used to extend insulation. For instance, a 10 K temperature reduction will extend the insulation life.

## Thermal class 130 (B)

- Nominal ambient temperature 40 °C
- Max permissible temperature rise 80 K
- Hot spot temperature margin 10 K

## Thermal class 155 (F)

- Nominal ambient temperature 40 °C
- Max permissible temperature rise 105 K
- Hot spot temperature margin 10 K

## Thermal class 180 (H)

- Nominal ambient temperature 40 °C
- Max permissible temperature rise 125 K
- Hot spot temperature margin 10 K

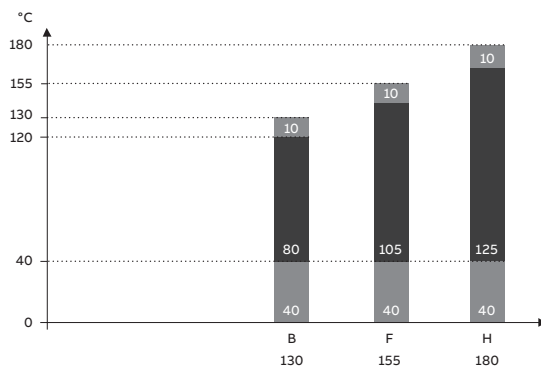

01

# General information

## Voltage and frequency

01 Voltage and frequency deviation in zones A and B.

The impact on temperature rise caused by voltage and frequency fluctuation is defined in IEC 60034-1. The standard divides the combinations into two zones, A and B. Zone A is the combination of voltage deviation of  $\pm 5\%$  and frequency deviation of  $\pm 2\%$ . Zone B is the combination of voltage deviation of  $\pm 10\%$  and frequency deviation of  $\pm 3\%$ . This is illustrated in figure below.

Motors are capable of supplying the rated torque in both zones A and B, but the temperature rise will be higher than at rated voltage and frequency. Motors can be run in zone B only for a short period of time.

Key	
X axis	frequency p.u.
Y axis	voltage p.u.
1	zone A
2	zone B (outside zone A)
3	rating point

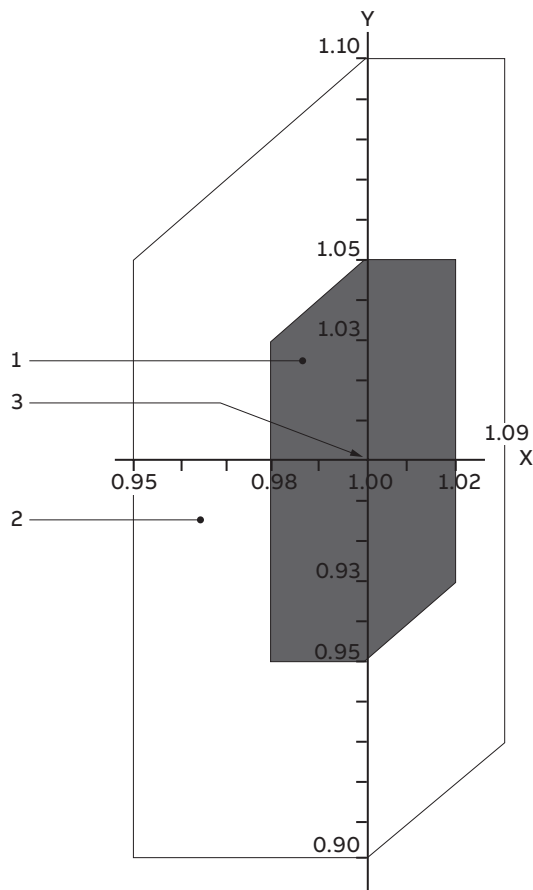

01



# General performance cast iron motors

Sizes 71 to 355, 0.18 to 355 kW

<b>14</b>	<b>Ordering information</b>
<b>15</b>	<b>Rating plates</b>
<b>16</b>	<b>Technical data IE2</b>
16	3000 r/min motors
17	1500 r/min motors
18	1000 r/min motors
<b>19</b>	<b>Technical data IE3</b>
19	3000 r/min motors
20	1500 r/min motors
21	1000 r/min motors
<b>22</b>	<b>Variant codes</b>
<b>24</b>	<b>Mechanical design</b>
24	Bearings
29	Terminal box
<b>30</b>	<b>Dimension drawings</b>
<b>31</b>	<b>Dimension drawings</b>
<b>33</b>	<b>Motors in brief</b>
33	Motor sizes 71 - 112
34	Motor sizes 132 - 250
35	Motor sizes 280-355

# Ordering information

## Explanation of the product code

Motor type	Motor size	Product code	Mounting arrangement code, Voltage and frequency code, Generation code	Variant codes
M2BAX	112MA	3GBA 112	310 - ADD	002, etc.
		1 2 3 4 5 6 7	8 9 10 11 12 13 14	

### Positions 1 to 4

3GBA: Totally enclosed fan cooled squirrel cage motor with cast iron frame

### Positions 5 and 6

IEC size

07:	71
08:	80
09:	90
10:	100
11:	112
13:	132
16:	160
18:	180
20:	200
22:	225
25:	250
28:	280
31:	315
35:	355

### Position 7

Speed (Pole pairs)

1:	2 poles
2:	4 poles
3:	6 poles

### Positions 8 to 10

Running number

### Position 11

-(dash)

### Position 12 (marked with black dot in data tables)

Mounting arrangement

A:	Foot-mounted, top-mounted terminal box
B:	Flange-mounted, large flange

### Position 13 (marked with black dot in data tables)

Voltage and frequency

### Position 13 (marked with black dot in data tables)

Single-speed motors

D:	400 VΔ, 690 VY, 380 VΔ, 660 VY, 50 Hz 440 VΔ, 460 VΔ, 60 Hz
S:	230 VΔ, 400 VY, 220 VΔ, 380 VY, 50 Hz 440 VY, 460 VΔ 60 Hz*

\*) M2AA 200 is not available for voltages less than 380 VD

### Position 14

A, B, C...= Generation code followed by variant codes

Efficiency values are given according to IEC 60034-2-1; 2014

For detailed dimension drawings please see our web-pages 'www.abb.com/motors&generators' or contact ABB.

\*) M2AA 200 is not available for voltages less than 380 VD



# Rating plates

01 Rating plate for IE2  
General performance cast  
iron M2BAX motor.



02 Rating plate for IE3  
General performance cast  
iron M2BAX motor.

The motor's main rating plate shows the motor's performance values with various connections at nominal speed. The rating plate also shows the efficiency level (IE2, IE3), year of manufacture, and the lowest nominal efficiency at 100, 75, and 50 % nominal load.

The lubrication plate specifies regreasing amount, regreasing interval in hours - depending on the mounting position and ambient temperature - and types of lubricant recommended.

							
							
<b>IE2</b> IEC60034-1							
<b>3- Motor</b> M2BAX 160MLA 4 IMB3/IM1001 2015							
<b>3030389-1</b>							
No. 3G1P194700429 Ins. cl. F IP 55							
V	Hz	kW	r/min	A	cos φ	Duty	
690 Y	50	11	1477	13.0	0.79	S1	
400 D	50	11	1477	22.4	0.79	S1	
660 Y	50	11	1474	13.2	0.82	S1	
380 D	50	11	1474	22.7	0.82	S1	
440 D	60	11	1778	18.7	0.81	S1	
460 D	60	11	1777	19.1	0.83	S1	
IE2-50Hz-89.8%(100%)-89.9%(75%)-89.2%(50%) / IE2-60Hz-91.0%(100%)							
Product code 3GBA162410-ADC							
6209-2Z/C3  6209-2Z/C3 134 kg							

01

							
							
<b>IE3</b> IEC60034-1							
<b>3- Motor</b> M2BAX 280SMC 4 IMB3/IM1001 2014							
<b>3026614-1</b>							
No. 3G1P144001206 Ins. cl. F IP 55							
V	Hz	kW	r/min	A	cos φ	Duty	
690 Y	50	90	1485	92	0.86	S1	
400 D	50	90	1485	159	0.86	S1	
660 Y	50	90	1483	96	0.87	S1	
380 D	50	90	1483	166	0.87	S1	
440 D	60	90	1785	144	0.86	S1	
460 D	60	90	1786	139	0.85	S1	
IE3-50Hz-95.2(100%)-95.6(75%)-95.5(50%) / IE3-60Hz-95.4(100%)							
Product code 3GBA282230-ADM							
6217/C3  6217/C3 621 kg							

02

# Technical data

## IE2 General performance cast iron motors

IP 55 - IC 411 - Insulation class F, temperature rise class B

IE2 efficiency class according to IEC 60034-30-1; 2014

Output kW	Motor type	Product code	Speed r/min	Efficiency IEC 60034-30-1; 2014			Power factor Cosφ	Current		Torque		Moment of inertia J = 1/4 GD <sup>2</sup> kgm <sup>2</sup>	Weight kg	Sound pressure Level L <sub>PA</sub> dB	
				Full load 100%	3/4 load 75%	1/2 load 50%		I <sub>N</sub> A	I <sub>s</sub> /I <sub>N</sub>	T <sub>N</sub> Nm	T <sub>i</sub> /T <sub>N</sub>				T <sub>b</sub> /T <sub>N</sub>
<b>3000 r/min = 2 poles</b>				<b>400 V 50 Hz</b>				<b>CENELEC-design</b>							
0.37	M2BAX 71MA 2	3GBA071310---C	2797	69,5	67,4	62,7	0,78	0,91	5,3	1,24	2,9	3,6	0,00033	9	56
0.55	M2BAX 71MB 2	3GBA071320---C	2811	74,1	72,8	69,5	0,79	1,3	5,4	1,85	3	3,5	0,00041	10	58
0.75	M2BAX 80MA 2	3GBA081310---C	2843	77,4	76,3	73,7	0,81	1,71	6,2	2,51	2,9	4,3	0,00067	14	63
1.1	M2BAX 80MB 2	3GBA081320---C	2840	79,6	79,5	77,6	0,83	2,44	6	3,67	3,1	3,8	0,0009	15	62
1.5	M2BAX 90SA 2	3GBA091110---C	2887	81,3	79,9	77,1	0,79	3,37	6,5	4,93	3	3,9	0,0021	21	66
2.2	M2BAX 90LA 2	3GBA091510---C	2894	83,2	83	81,4	0,84	4,48	7,7	7,25	3,1	3,8	0,0027	24	67
3	M2BAX 100LA 2	3GBA101510---C	2919	84,6	83,6	81,3	0,84	6,12	8,7	9,81	4,1	5	0,0048	32	74
4	M2BAX 112MA 2	3GBA111310---C	2916	85,8	85,3	83,1	0,86	7,89	9,1	13,08	4,1	4,7	0,00561	36	74
5.5	M2BAX 132SA 2	3GBA131110---C	2921	87	86	83,7	0,85	10,8	8,3	18,02	2,6	4,3	0,0117	56	74
7.5	M2BAX 132SB 2	3GBA131120---C	2916	88,1	87,5	85,7	0,84	14,5	8,7	24,57	3,1	4,5	0,0132	60	72
11	M2BAX 160MLA 2	3GBA161410---C	2931	89,4	89,4	88,3	0,86	20,7	6,6	35,87	2,5	3,5	0,041	103	72
15	M2BAX 160MLB 2	3GBA161420---C	2938	90,3	90,5	89,8	0,88	27	7,6	48,89	3,1	3,5	0,0538	116	72
18.5	M2BAX 160MLC 2	3GBA161430---C	2939	90,9	91	90,3	0,87	33,4	7,9	60,13	3,1	3,8	0,06	124	73
22	M2BAX 180MLA 2	3GBA181410---C	2943	91,3	91,6	90,9	0,87	39,5	8,6	71,4	3,7	3,9	0,0735	151	72
30	M2BAX 200MLA 2	3GBA201410---C	2957	92	91,5	90,1	0,85	55,8	8,6	97,1	4	4,2	0,11	198	81
37	M2BAX 200MLB 2	3GBA201420---C	2951	92,5	92,5	92,2	0,9	64,2	7,9	120	3,6	3,7	0,141	229	80
45	M2BAX 225SMA 2	3GBA221210---C	2962	92,9	92,8	92,1	0,86	80,6	8,8	145,3	3,8	3,8	0,226	275	82
55	M2BAX 250SMA 2	3GBA251210---C	2965	94,3	94,3	93,7	0,87	96,4	7,4	177,1	3,4	3	0,344	335	78
75	M2BAX 280SA 2	3GBA281110---C	2975	93,8	93,2	91,8	0,87	133	7,6	240,5	2,3	3,3	0,8	546	78
90	M2BAX 280SMB 2	3GBA281220---C	2976	94,1	93,9	92,8	0,89	155	7,4	288,83	2,2	3	0,9	570	78
110	M2BAX 315SMA 2	3GBA311210---C	2981	94,3	93,8	92,5	0,84	199	7,7	352,3	2,1	3,2	1,2	750	78
132	M2BAX 315SMB 2	3GBA311220---C	2978	94,6	94,2	93,2	0,86	233	7,8	422,7	2,4	3,9	1,4	810	78
160	M2BAX 315SMC 2	3GBA311230---C	2981	94,8	94,6	93,8	0,88	274	7,5	513,1	2,2	3,7	1,7	900	78
200	M2BAX 315MLA 2	3GBA311410---C	2979	95	94,8	93,9	0,89	341	7,2	640,9	2,4	3,6	2,1	1020	83
250	M2BAX 355SMA 2	3GBA351210---C	2983	95	94,7	93,7	0,89	428	6,7	800	1,5	2,8	2,7	1310	83
315	M2BAX 355SMB 2	3GBA351220---C	2980	95	95	94,2	0,89	537	7,2	1009	1,9	2,8	3,4	1450	83
355	M2BAX 355SMC 2	3GBA351230---C	2983	95	95	94,3	0,88	609	7,4	1136	2,1	2,7	3,6	1520	83



# Technical data

## IE2 General performance cast iron motors

IP 55 - IC 411 - Insulation class F, temperature rise class B

IE2 efficiency class according to IEC 60034-30-1; 2014

Output kW	Motor type	Product code	Speed r/min	Efficiency IEC 60034-30-1; 2014			Power factor Cosφ	Current		Torque		Moment of inertia J = 1/4 GD <sup>2</sup> kgm <sup>2</sup>	Weight kg	Sound pressure Level L <sub>PA</sub> dB	
				Full load 100%	3/4 load 75%	1/2 load 50%		I <sub>N</sub> A	I <sub>s</sub> /I <sub>N</sub>	T <sub>N</sub> Nm	T <sub>i</sub> /T <sub>N</sub>				T <sub>b</sub> /T <sub>N</sub>
<b>1500 r/min = 4 poles</b>				<b>400 V 50 Hz</b>				<b>CENELEC-design</b>							
0.25	M2BAX 71MA 4	3GBA072310...C	1424	68,5	65,1	58,6	0,7	0,74	4,6	1,68	2	2,9	9	49	
0.37	M2BAX 71MB 4	3GBA072320...C	1418	72,7	70,4	65	0,69	1,08	5	2,5	2,5	3	10	46	
0.55	M2BAX 80MA 4	3GBA082310...C	1441	77,1	75,4	71,3	0,73	1,41	6,4	3,66	2,8	3,4	15	54	
0.75	M2BAX 80MB 4	3GBA082320...C	1446	79,6	78,8	74,9	0,69	1,99	6,6	4,97	3,7	3,9	0,00247	18	53
1.1	M2BAX 90SA 4	3GBA092110...C	1447	81,4	79,6	75,6	0,71	2,74	6,6	7,35	3,9	4,3	0,0037	22	51
1.5	M2BAX 90LA 4	3GBA092510...C	1444	82,8	83,1	81,3	0,73	3,6	6,8	10	3,7	4,2	0,0046	24	55
2.2	M2BAX 100LA 4	3GBA102510...C	1445	84,3	83,8	81,5	0,77	4,93	7,3	14,54	3,2	3,9	0,00759	31	55
3	M2BAX 100LB 4	3GBA102520...C	1443	85,5	85,2	83,4	0,77	6,61	7,6	19,8	3,8	4,3	0,00939	35	58
4	M2BAX 112MA 4	3GBA112310...C	1442	86,6	86,2	84,6	0,78	8,62	7,5	26,5	4	4,3	0,012	41	56
5.5	M2BAX 132SA 4	3GBA132110...C	1457	87,7	87,5	86,2	0,77	11,7	6,9	36	2,5	3,4	0,0257	59	65
7.5	M2BAX 132MA 4	3GBA132310...C	1457	88,7	88,6	87,4	0,77	16	7,2	49,1	2,6	3,6	0,032	70	67
11	M2BAX 160MLA 4	3GBA162410...C	1466	89,8	89,9	89,2	0,78	22,8	7	71,51	3,3	3,2	0,078	111	66
15	M2BAX 160MLB 4	3GBA162420...C	1468	90,6	91,1	90,5	0,81	29,5	8	97,71	3,2	3,7	0,1	126	66
18.5	M2BAX 180MLA 4	3GBA182410...C	1470	91,2	91,4	90,5	0,79	36,9	8,5	120,4	3,7	4,2	0,12	156	65
22	M2BAX 180MLB 4	3GBA182420...C	1472	91,6	91,3	90,2	0,77	45	9,2	143	4,1	4,6	0,139	169	66
30	M2BAX 200MLA 4	3GBA202410...C	1476	92,3	92,4	92	0,81	58,4	6,8	193,6	3	3,2	0,236	222	68
37	M2BAX 225SMA 4	3GBA222210...C	1479	92,7	92,7	92,2	0,82	70,6	7,4	238,9	3,1	3,3	0,35	265	69
45	M2BAX 225SMB 4	3GBA222220...C	1481	93,1	92,9	92,3	0,8	87,2	7,9	290,4	3,4	3,4	0,416	292	69
55	M2BAX 250SMA 4	3GBA252210...C	1480	93,5	93,4	92,7	0,82	104	7,6	355,4	3,3	3,3	0,533	340	77
75	M2BAX 280SA 4	3GBA282110...C	1484	94	94,1	93,4	0,85	135	6,9	482,63	2,6	2,9	1,25	515	71
90	M2BAX 280SMB 4	3GBA282220...C	1481	94,2	94,3	94	0,86	160	6,9	579,6	2,6	2,9	1,5	575	71
110	M2BAX 315SMA 4	3GBA312210...C	1488	94,5	94,3	93,5	0,85	197	6,9	705,79	2,3	2,9	2,3	775	78
132	M2BAX 315SMB 4	3GBA312220...C	1487	94,7	94,7	93,9	0,86	236	6,9	847	2,3	2,7	2,6	830	78
160	M2BAX 315SMC 4	3GBA312230...C	1487	94,9	95	94,2	0,85	288	7,2	1027	2,4	2,9	2,9	870	78
200	M2BAX 315MLA 4	3GBA312410...C	1486	95,1	95,2	94,6	0,86	356	7	1285	2,3	2,8	3,5	995	78
250	M2BAX 355SMA 4	3GBA352210...C	1488	95,1	95,1	94,2	0,85	445	6,7	1604	2	2,6	5,4	1400	82
315	M2BAX 355SMB 4	3GBA352220...C	1488	95,1	95,1	94,3	0,85	560	7,3	2021	2,2	2,7	6,9	1570	82
355	M2BAX 355SMC 4	3GBA352230...C	1487	95,1	95,3	94,7	0,86	623	6,8	2279	2,4	2,7	7,2	1650	82

# Technical data

## IE2 General performance cast iron motors

IP 55 - IC 411 - Insulation class F, temperature rise class B

IE2 efficiency class according to IEC 60034-30-1; 2014

Output kW	Motor type	Product code	Speed r/min	Efficiency IEC 60034-30-1; 2014			Power factor Cosφ	Current		Torque		Moment of inertia J = 1/4 GD <sup>2</sup> kgm <sup>2</sup>	Weight kg	Sound pressure Level L <sub>PA</sub> dB	
				Full load 100%	3/4 load 75%	1/2 load 50%		I <sub>N</sub> A	I <sub>s</sub> /I <sub>N</sub>	T <sub>N</sub> Nm	T <sub>i</sub> /T <sub>N</sub>				T <sub>b</sub> /T <sub>N</sub>
<b>1000 r/min = 6 poles</b>				<b>400 V 50 Hz</b>				<b>CENELEC-design</b>							
0.18	M2BAX 71MA 6	3GBA073310...C	905	59	54,9	48,1	0,72	0,65	3,5	1,84	2,2	2,6	0,00082	9	40
0.25	M2BAX 71MB 6	3GBA073320...C	920	63	58,6	51,8	0,71	0,83	3,8	2,56	2,6	3,1	0,00105	10	47
0.37	M2BAX 80MA 6	3GBA083310...C	916	67,6	65,8	60,4	0,71	1,19	3,9	3,85	2,4	2,8	0,00173	14	49
0.55	M2BAX 80MB 6	3GBA083320...C	932	73,1	71,1	66,5	0,65	1,67	4,7	5,61	3	3,1		19	47
0.75	M2BAX 90SA 6	3GBA093110...C	951	75,9	73,3	68,2	0,6	2,36	4,9	7,6	3,3	3,7	0,0044	22	50
1.1	M2BAX 90LA 6	3GBA093510...C	936	78,1	76,5	73	0,65	3,17	4,6	11,06	3	3,3	0,0051	25	48
1.5	M2BAX 100LA 6	3GBA103510...C	957	79,8	78,1	74	0,63	4,36	5,7	15	2,6	3,3	0,00795	31	56
3	M2BAX 132SA 6	3GBA133110...C	966	83,3	82,6	80,8	0,64	8,09	5,6	29,43	1,9	3	0,0251	57	62
4	M2BAX 132MA 6	3GBA133310...C	964	84,6	84,3	82,7	0,69	9,95	6,4	39,76	2,7	3,3	0,0294	65	59
5.5	M2BAX 132MB 6	3GBA133320...C	964	86	85,9	84,6	0,66	14	5,8	54,2	2,2	2,9	0,0397	79	62
7.5	M2BAX 160MLA 6	3GBA163410...C	974	87,2	87,5	86,9	0,74	16,4	6,6	73,69	2	3,2	0,0811	114	65
11	M2BAX 160MLB 6	3GBA163420...C	971	88,7	89,3	89,7	0,78	22,9	6,6	108,2	1,3	2,8	0,102	134	57
15	M2BAX 180MLA 6	3GBA183410...C	971	89,7	90	89,6	0,76	32	7,4	147	2,4	3,9	0,136	169	62
18.5	M2BAX 200MLA 6	3GBA203410...C	978	90,4	90,7	90	0,76	38,5	6,1	180,8	2	2,9	0,204	205	61
22	M2BAX 200MLB 6	3GBA203420...C	978	90,9	91,1	90,5	0,76	45,6	6,2	215,3	1,8	2,9	0,227	219	62
30	M2BAX 225SMA 6	3GBA223210...C	987	91,7	91,5	90,5	0,78	60,6	7	290	2,7	3,2	0,579	284	64
37	M2BAX 250SMA 6	3GBA253210...C	986	92,2	92,5	91,9	0,8	71,9	6,9	358,5	2,6	2,9	0,783	337	66
45	M2BAX 280SA 6	3GBA283110...C	990	92,7	92,8	91,9	0,83	84,3	6,7	434,18	2,7	2,6	1,85	500	71
55	M2BAX 280SB 6	3GBA283120...C	990	93,1	93,4	92,6	0,83	102	6,9	530,66	2,8	2,6	2,2	540	71
75	M2BAX 315SMA 6	3GBA313210...C	992	93,7	93,7	92,6	0,81	143	7	721	2,1	2,7	3,2	705	75
90	M2BAX 315SMB 6	3GBA313220...C	992	94	94,1	93,2	0,83	165	7,2	866	2,1	2,7	4,1	800	75
110	M2BAX 315SMC 6	3GBA313230...C	992	94,3	94,4	93,7	0,83	203	7	1058	2,2	2,7	4,9	870	75
132	M2BAX 315MLA 6	3GBA313410...C	992	94,6	94,7	94	0,83	243	7,2	1270	2,4	2,7	5,8	980	75
160	M2BAX 355SMA 6	3GBA353210...C	992	94,8	94,9	94,2	0,83	293	6,2	1540	2,1	2,3	7,3	1290	77
200	M2BAX 355SMB 6	3GBA353220...C	992	95	95,2	94,6	0,84	360	6,5	1925	2,1	2,3	9,7	1440	77
250	M2BAX 355SMC 6	3GBA353230...C	991	95	95,2	94,8	0,84	450	6,7	2409	2,3	2,3	11,3	1590	77

# Technical data

## IE3 General performance cast iron motors

IP 55 - IC 411 - Insulation class F, temperature rise class B

IE3 efficiency class according to IEC 60034-30-1; 2014

Output kW	Motor type	Product code	Speed r/min	Efficiency IEC 60034-30-1; 2014			Power factor Cosφ	Current		Torque		Moment of inertia J = 1/4 GD <sup>2</sup> kgm <sup>2</sup>	Weight kg	Sound pressure Level L <sub>PA</sub> dB	
				Full load 100%	3/4 load 75%	1/2 load 50%		I <sub>N</sub> A	I <sub>s</sub> /I <sub>N</sub>	T <sub>N</sub> Nm	T <sub>i</sub> /T <sub>N</sub>				T <sub>b</sub> /T <sub>N</sub>
<b>3000 r/min = 2 poles</b>				<b>400 V 50 Hz</b>				<b>CENELEC-design</b>							
0.37	M2BAX 71MC 2	3GBA071330---D	2819	76,5	76	73,4	0,8	0,86	6,6	1,26	2,7	3,2	0,00035	10	50
0.55	M2BAX 71MB 2	3GBA071320---D	2816	78,4	78,1	75,9	0,8	1,27	6,1	1,88	2,7	3,2	0,0004	10	49
1.1	M2BAX 80MD 2	3GBA081340---D	2862	82,7	83,1	82,4	0,81	2,37	7,5	3,67	3,2	4	0,00102	17	59
1.5	M2BAX 90SB 2	3GBA091120---D	2913	84,2	84,1	82,6	0,84	3,02	8,7	4,93	2,9	3,9	0,00234	23	54
2.2	M2BAX90SLA 2	3GBA091010---D	2917	85,9	85,6	84,2	0,83	4,39	9,8	7,22	3,4	4,2	0,003	26	66
3	M2BAX 100LKA 2	3GBA101810---D	2908	87,1	88,1	87,8	0,91	5,41	9,7	9,79	3,1	4	0,00691	42	60
4	M2BAX 112MB 2	3GBA111320---D	2904	88,1	89	89,2	0,9	7,23	9,3	13,19	2,8	3,7	0,00711	42	64
5.5	M2BAX 132SMA 2	3GBA131210---D	2934	89,2	89,8	89	0,82	10,6	8,9	17,91	2,4	4,1	0,0136	64	65
7.5	M2BAX 132SME 2	3GBA131250---D	2901	90,1	91,1	91,2	0,91	13,1	7,3	24,72	2,2	3,7	0,02	83	71
11	M2BAX 160MLA 2	3GBA161410---F	2943	91,2	92	91,6	0,91	19,1	7,2	35,57	2,6	3,6	0,057	121	69
15	M2BAX 160MLB 2	3GBA161420---F	2947	91,9	92,2	91,8	0,88	26,5	8,2	48,49	3,2	4,2	0,063	128	69
18.5	M2BAX 160MLC 2	3GBA161430---F	2949	92,4	93	92,6	0,9	32	9	59,81	3,3	3,9	0,076	145	73
22	M2BAX 180MLA 2	3GBA181410---F	2941	92,7	93	92,7	0,84	41,1	8,7	71,42	3,4	4,1	0,073	152	70
30	M2BAX 200MLA 2	3GBA201410---F	2961	93,3	93,3	92,6	0,89	52	10	96,89	3,7	4,1	0,144	250	80
37	M2BAX 200MLB 2	3GBA201420---F	2951	93,7	93,9	93,3	0,89	63,9	10,5	119	4,2	4,1	0,16	268	78
45	M2BAX 225SMA 2	3GBA221210---F	2962	94	94	93,3	0,85	81,3	9,3	145,4	3,8	4,1	0,223	278	80
55	M2BAX 250SMA 2	3GBA251210---F	2965	94,3	94,3	93,7	0,87	96,4	7,4	177,1	3,4	3	0,344	335	78
75	M2BAX 280SMB 2	3GBA281220---M	2978	94,7	94,6	93,6	0,88	130	7	240	2,3	3	0,9	596	74
90	M2BAX 280SMC 2	3GBA281230---M	2975	95	95	94,2	0,88	156	6,4	289	2,1	2,8	0,99	618	74
110	M2BAX 315SMB 2	3GBA311220---M	2982	95,2	94,9	93,9	0,87	192	7	352	1,8	2,7	1,3	801	78
132	M2BAX 315SMC 2	3GBA311230---M	2982	95,4	95,4	94,6	0,87	229	6,8	422	2	2,8	1,5	852	78
160	M2BAX 315SMD 2	3GBA311240---M	2983	95,6	95,6	94,9	0,87	275	7,4	512	2,2	2,8	1,7	909	78
200	1) M2BAX 315MLA 2	3GBA311410---M	2983	95,8	96	95,5	0,88	342	7,5	640	2,3	3,1	2,1	1051	81
250	M2BAX 355SMA 2	3GBA351210---M	2985	95,8	95,6	94,6	0,89	423	7,7	800	2,1	3,3	3	1412	83
315	M2BAX 355SMB 2	3GBA351220---M	2980	95,8	95,7	95	0,89	529	7	1009	2,1	3	3,4	1495	83
355	M2BAX 355SMC 2	3GBA351230---M	2984	95,8	95,8	95	0,88	605	7,2	1136	2,2	3	3,6	1565	83

<sup>1)</sup> Temperature rise class F

# Technical data

## IE3 General performance cast iron motors

IP 55 - IC 411 - Insulation class F, temperature rise class B  
IE3 efficiency class according to IEC 60034-30-1; 2014

Output kW	Motor type	Product code	Speed r/min	Efficiency IEC 60034-30-1; 2014			Power factor Cosφ	Current			Torque		Moment of inertia J = 1/4 GD <sup>2</sup> kgm <sup>2</sup>	Weight kg	Sound pressure Level L <sub>PA</sub> dB
				Full load 100%	3/4 load 75%	1/2 load 50%		I <sub>N</sub> A	I <sub>s</sub> /I <sub>N</sub>	T <sub>N</sub> Nm	T <sub>i</sub> /T <sub>N</sub>	T <sub>b</sub> /T <sub>N</sub>			
<b>1500 r/min = 4 poles</b>				<b>400 V 50 Hz</b>				<b>CENELEC-design</b>							
0.25	M2BAX 71MB 4	3GBA072320---D	1440	73,5	70,1	63,8	0,64	0,78	6,1	1,67	2,7	3,5	0,00075	10	41
0.37	M2BAX 71MLA 4	3GBA072410---D	1441	77,3	74,9	69,8	0,66	1,06	6,8	2,47	2,7	3,8	0,00098	12	50
0.55	M2BAX 80MC 4	3GBA082330---D	1445	80,8	80,8	78,1	0,75	1,31	7,8	3,64	2,6	3,9	0,00228	17	48
0.75	M2BAX 80MLA 4	3GBA082410---D	1444	82,5	81,3	78	0,72	1,79	8,4	4,86	3,8	4,6	0,00295	21	48
1.1	M2BAX 90SB 4	3GBA092120---D	1439	84,1	83,2	80,9	0,74	2,57	7,7	7,23	3,6	4,2	0,00394	23	47
1.5	M2BAX 90SLA 4	3GBA092010---D	1444	85,3	84,2	81,3	0,7	3,65	8,3	9,87	4,6	5,4	0,00485	25	44
2.2	M2BAX 100LB 4	3GBA102520---D	1451	86,7	86,6	84,5	0,77	4,77	9,2	14,54	3,4	4,4	0,00863	34	50
3	M2BAX 100LKA 4	3GBA102810---D	1450	87,7	87,6	86,5	0,8	6,18	9,8	19,78	3,7	4,6	0,0115	41	56
4	M2BAX 112MLA 4	3GBA112410---D	1443	88,6	88,9	88,1	0,81	8,11	9,4	26,53	3,6	4,4	0,0152	50	57
5.5	M2BAX 132SMA 4	3GBA132210---D	1463	89,6	90,4	90,2	0,77	11,5	7,9	35,89	2,6	3,3	0,0297	67	68
7.5	M2BAX 132SME 4	3GBA132250---D	1465	90,4	90,7	90,3	0,78	15,5	7,4	48,96	2,5	4	0,037	77	60
11	M2BAX 160MLA 4	3GBA162410---F	1477	91,4	91,8	91,1	0,82	21,1	7,6	71,27	2,6	3,3	0,11	136	61
15	M2BAX 160MLB 4	3GBA162420---F	1477	92,1	92,4	91,6	0,82	28,5	8,2	96,99	3	3,7	0,135	161	61
18.5	M2BAX 180MLA 4	3GBA182410---F	1472	92,6	92,6	92	0,82	35	10,3	120,1	3,6	4	0,135	169	64
22	M2BAX 180MLB 4	3GBA182420---F	1473	93	93,2	92,5	0,8	42,8	10,1	142,58	3,3	4,2	0,167	198	65
30	M2BAX 200MLA 4	3GBA202410---F	1481	93,6	94	93,5	0,82	56,3	10	192,76	3,9	3	0,32	282	69
37	M2BAX 225SMA 4	3GBA222210---F	1479	93,9	94,2	93,7	0,81	70,3	9,3	237,79	2,5	3	0,376	278	67
45	M2BAX 225SMB 4	3GBA222220---F	1481	94,2	94,4	93,8	0,79	87,8	9,1	288,31	4,2	3,6	0,415	293	68
55	M2BAX 250SMA 4	3GBA252210---F	1479	94,6	94,7	94	0,83	102	10,1	351,77	4,4	3,4	0,62	386	74
75	M2BAX 280SMB 4	3GBA282220---M	1485	95	95,2	94,8	0,86	133	6,4	483	2,3	2,8	1,38	573	75
90	M2BAX 280SMC 4	3GBA282230---M	1485	95,2	95,3	94,8	0,86	159	7,1	588	2,5	2,9	1,73	636	75
110	M2BAX 315SMB 4	3GBA312220---M	1489	95,4	95,4	94,8	0,85	196	7	705	2,1	3	2,43	823	71
132	M2BAX 315SMC 4	3GBA312230---M	1488	95,6	95,8	95,3	0,86	231	6,7	847	2,2	2,9	2,9	892	71
160	M2BAX 315SMD 4	3GBA312240---M	1488	95,8	96	95,8	0,85	282	6,9	1026	2,2	3	3,2	933	71
200	M2BAX 315MLB 4	3GBA312420---M	1487	96	96,4	96,4	0,86	351	6,8	1284	2,4	3	3,9	1091	74
250	M2BAX 355SMA 4	3GBA352210---M	1491	96	96	95,6	0,86	435	6,4	1601	2,1	2,9	5,9	1445	78
315	M2BAX 355SMB 4	3GBA352220---M	1491	96	96	95,6	0,86	545	6,7	2018	2,3	3	6,9	1595	78
355	M2BAX 355SMC 4	3GBA352230---M	1490	96	96,2	95,8	0,86	616	6,3	2273	2,3	2,8	7,2	1635	78

# Technical data

## IE3 General performance cast iron motors

IP 55 - IC 411 - Insulation class F, temperature rise class B  
IE3 efficiency class according to IEC 60034-30-1; 2014

Output kW	Motor type	Product code	Speed r/min	Efficiency IEC 60034-30-1; 2014			Power factor Cosφ	Current		Torque		Moment of inertia J = 1/4 GD <sup>2</sup> kgm <sup>2</sup>	Weight kg	Sound pressure Level L <sub>PA</sub> dB	
				Full load 100%	3/4 load 75%	1/2 load 50%		I <sub>N</sub> A	I <sub>s</sub> /I <sub>N</sub>	T <sub>N</sub> Nm	T <sub>i</sub> /T <sub>N</sub>				T <sub>b</sub> /T <sub>N</sub>
<b>1000 r/min = 6 poles</b>				<b>400 V 50 Hz</b>				<b>CENELEC-design</b>							
0.18	M2BAX 71MB 6	3GBA073320---D	931	63,9	60	53,2	0,69	0,6	3,8	1,87	2,1	2,6	0,00103	10	39
0.25	M2BAX 71MLA 6	3GBA073410---D	926	68,6	66,3	60,9	0,67	0,8	4,3	2,58	2,6	2,9	0,0014	13	46
0.37	M2BAX 80MC 6	3GBA083330---D	940	73,5	71,2	66,4	0,67	1,08	5,8	3,77	2,8	3,2	0,0024	17	42
1.1	M2BAX 90LB 6	3GBA093520---D	954	81	79,2	75,5	0,63	3,13	6	11,05	3,3	3,8	0,00643	30	53
1.5	M2BAX 100LKA 6	3GBA103810---D	955	82,5	82	79,7	0,66	3,95	5,4	15,01	2,8	3,1	0,00975	37	48
2.2	M2BAX 112MLA 6	3GBA113410---D	957	84,3	83,6	81,5	0,65	5,85	6,7	21,84	2,9	3,7	0,013	46	49
3	M2BAX 132SMA 6	3GBA133210---D	968	85,6	86,3	84,9	0,68	7,33	6,8	29,58	2,2	3,2	0,0291	65	48
4	M2BAX 132SMB 6	3GBA133220---D	972	86,8	86,8	84,9	0,65	10,1	7	39,32	2,7	3,6	0,0343	71	52
5.5	M2BAX 132MLA 6	3GBA133410---D	974	88	87,4	86	0,67	13,5	7,3	54,2	2,9	3,5	0,0511	97	65
7.5	M2BAX 160MLA 6	3GBA163410---F	979	89,1	89,5	88,9	0,75	15,9	7,6	73,39	1,8	3,1	0,099	131	59
11	M2BAX 160MLB 6	3GBA163420---F	976	90,3	91,3	91,3	0,78	22,5	7,8	107,71	1,9	3	0,134	161	57
15	M2BAX 180MLA 6	3GBA183410---F	971	91,2	91,8	91,2	0,75	31,8	9,4	146,02	2,3	3,6	0,162	197	63
18.5	M2BAX 200MLA 6	3GBA203410---F	978	91,7	92,1	91,5	0,75	38,8	6,7	180,06	2,1	2,8	0,207	208	64
22	M2BAX 200MLB 6	3GBA203420---F	978	92,2	92,5	91,8	0,75	45,9	7,3	213,75	2,3	3	0,255	251	62
30	M2BAX 225SMA 6	3GBA223210---F	988	92,9	93,3	92,7	0,79	59	8,2	290,09	2,9	3,3	0,592	286	63
37	M2BAX 250SMA 6	3GBA253210---F	986	93,3	93,6	93,1	0,79	72,4	8,5	353,33	3,3	3	0,83	360	64
45	M2BAX 280SMB 6	3GBA283220---M	991	93,7	94	93,5	0,84	81,9	7,4	433	2,7	3	1,87	562	72
55	M2BAX 280SMC 6	3GBA283230---M	993	94,1	94,3	93,8	0,86	98,2	7,5	530	2,8	3	2,57	615	71
75	M2BAX 315SMB 6	3GBA313220---M	994	94,6	94,9	94,6	0,84	136	6,8	720	1,8	2,6	4,1	791	75
90	M2BAX 315SMC 6	3GBA313230---M	994	94,9	95,1	94,7	0,84	164	7,2	864	2	3	4,6	859	76
110	M2BAX 315SMD 6	3GBA313240---M	994	95,1	95,3	95	0,83	200	7,3	1056	2,2	3,1	4,9	912	75
132	M2BAX 315MLB 6	3GBA313420---M	995	95,4	95,5	95,1	0,82	242	7,3	1266	2,3	3,2	6,3	1068	72
160	M2BAX 355SMA 6	3GBA353210---M	993	95,6	95,9	95,6	0,82	292	6,7	1538	2,5	2,6	7,9	1348	75
200	M2BAX 355SMB 6	3GBA353220---M	993	95,8	96,2	96,1	0,82	365	6,7	1923	2,6	2,5	9,7	1512	75
250	M2BAX 355SMC 6	3GBA353230---M	993	95,8	96,1	95,8	0,81	464	7,7	2404	3	3,1	11,3	1656	75

# Variant codes

## IE3 and IE2 General performance cast iron motors

Variant codes specify additional options and features to the standard motor. The desired features are listed as three-digit variant codes in the motor order. Note also that there are variants that cannot be used together.

Most of the variant codes apply to IE2 and IE3 motors. For details please contact your ABB sales office before making an order.

Code/Variants M2BAX	Frame size													
	71	80	90	100	112	132	160	180	200	225	250	280	315	355
<b>Bearings and Lubrication</b>														
037	-	-	-	-	-	-	•	•	•	•	•	•	•	•
041	-	-	-	-	-	-	•	•	•	•	•	○	○	○
043	-	-	-	-	-	-	•	•	•	•	•	-	-	-
<b>Branch standard designs</b>														
178	•	•	•	•	•	•	•	•	•	•	•	•	•	•
<b>Cooling system</b>														
068	•	•	•	•	•	•	•	•	•	•	•	•	•	•
183	•	•	•	•	•	•	•	•	•	•	•	•	•	-
<b>Drain holes</b>														
065	•	•	•	•	•	•	•	•	•	•	•	•	•	•
<b>Heating elements</b>														
450	•	•	•	•	•	•	•	•	•	•	•	•	•	•
451	•	•	•	•	•	•	•	•	•	•	•	•	•	•
<b>Marine</b>														
096	•	•	•	•	•	•	•	•	•	•	•	•	•	•
186	•	•	•	•	•	•	•	•	•	•	•	•	•	•
492	•	•	•	•	•	•	•	•	•	•	•	•	•	•
496	•	•	•	•	•	•	•	•	•	•	•	•	•	•
675	•	•	•	•	•	•	•	•	•	•	•	•	•	•
676	•	•	•	•	•	•	•	•	•	•	•	•	•	•
<b>Mounting arrangements</b>														
008	•	•	•	•	•	•	-	-	-	-	-	-	-	-
009	•	•	•	•	•	•	•	•	•	•	•	•	•	•
047	•	•	•	•	•	•	-	-	-	-	-	-	-	-
048	•	•	•	•	•	•	-	-	-	-	-	-	-	-
066	•	•	•	•	•	•	•	•	•	•	•	•	•	•
<b>Painting</b>														
114	•	•	•	•	•	•	•	•	•	•	•	•	•	•
<b>Protection</b>														
005	•	•	•	•	•	•	•	•	•	•	•	•	•	•
072	•	•	•	•	•	•	•	•	•	•	•	•	•	•
158	•	•	•	•	•	•	•	•	•	•	•	•	•	•
403	•	•	•	•	•	•	•	•	•	•	•	•	•	•
784	•	•	•	•	•	•	•	•	•	•	•	•	•	•
<b>Rating &amp; instruction plates</b>														
002	•	•	•	•	•	•	•	•	•	•	•	•	•	•
095	•	•	•	•	•	•	•	•	•	•	•	•	•	•
098	○	○	○	○	○	○	○	○	○	○	○	○	○	○
135	•	•	•	•	•	•	•	•	•	•	•	•	•	•
159	•	•	•	•	•	•	•	•	•	•	•	•	•	•
161	•	•	•	•	•	•	•	•	•	•	•	-	-	-
163	•	•	•	•	•	•	•	•	•	•	•	•	•	•

○ = Included as standard | • = Available as option | - = Not applicable

Code/Variants M2BAX	Frame size													
	71	80	90	100	112	132	160	180	200	225	250	280	315	355
<b>Standards and Regulations</b>														
331	IE1 motor not for sale for use in EU	●	●	●	●	●	●	●	●	●	●	-	-	-
540	China energy label	●	●	●	●	●	●	●	●	●	●	●	●	●
544	Australian HE MEPS IE3 motors only.	-	-	-	-	-	●	●	●	●	●	●	●	●
822	WIMES 3.03i6 Compliant Design for DOL operation IE3 motors only.	●	●	●	●	●	●	●	●	●	●	●	●	●
823	WIMES 3.03i6 Compliant Design for VSD operation IE3 motors only.	●	●	●	●	●	●	●	●	●	●	●	●	●
<b>Stator winding temperature sensors</b>														
122	Bimetal detectors, break type (NCC), (3 in series), 150 °C, in stator winding	●	●	●	●	●	●	●	●	●	●	●	●	●
435	PTC - thermistors (3 in series), 130 °C, in stator winding	●	●	●	●	●	●	●	●	●	●	●	●	●
436	PTC - thermistors (3 in series), 150 °C, in stator winding	○	○	○	○	○	○	○	○	○	○	○	○	○
439	PTC - thermistors (2x3 in series), 150 °C, in stator winding	●	●	●	●	●	●	●	●	●	●	●	●	●
441	PTC - thermistors (3 in series, 130 °C & 3 in series, 150 °C), in stator winding	●	●	●	●	●	●	●	●	●	●	●	●	●
445	Pt100 2-wire in stator winding, 1 per phase	●	●	●	●	●	●	●	●	●	●	●	●	●
<b>Terminal box</b>														
022	Cable entry LHS (seen from D-end).	●	●	●	●	●	●	●	●	●	●	●	●	●
230	Standard metal cable gland.	●	●	●	●	●	●	●	●	●	●	●	●	●
375	Standard plastic cable gland	●	●	●	●	●	●	●	●	●	●	-	-	-
376	Two standard plastic cable glands	●	●	●	●	●	●	●	●	●	●	-	-	-
400	4 x 90 degr turnable terminal box.	●	●	●	●	●	●	●	●	●	●	○	○	○
418	Separate terminal box for auxiliaries, standard material.	●	●	●	●	●	●	●	●	●	●	-	-	-
447	Top mounted separate terminal box for monitoring equipment.	-	-	-	-	-	-	-	-	-	-	●	●	●
468	Cable entry from D-end.	-	-	-	-	-	-	-	-	-	-	●	●	●
731	Two standard metal cable glands.	●	●	●	●	●	●	●	●	●	●	●	●	●
<b>Testing</b>														
145	Type test report from a catalogue motor, 400V 50Hz.	●	●	●	●	●	●	●	●	●	●	●	●	●
148	Routine test report.	●	●	●	●	●	●	●	●	●	●	●	●	●
<b>Variable speed drives</b>														
470	Prepared for hollow shaft pulse tacho (L&L equivalent).	-	-	-	-	-	-	●	●	●	●	●	-	-
472	1024 pulse tacho (L&L 861007455-1024).	-	-	-	-	-	-	●	●	●	●	●	-	-
473	2048 pulse tacho (L&L 861007455-2048).	-	-	-	-	-	-	●	●	●	●	●	-	-
701	Insulated bearing at N-end.	-	-	-	-	-	-	-	-	-	-	-	●	●
704	EMC cable entry.	●	●	●	●	●	●	●	●	●	●	●	●	●

○ = Included as standard | ● = Available as option | - = Not applicable

# Mechanical design

## Bearings

General performance motors are normally fitted with single-row deep-groove ball bearings, as shown in the table below.

If the bearing at the D-end is replaced with a roller bearing (NU- or NJ-), higher radial forces can be handled. Roller bearings are suitable for belt-drive applications and can be ordered with variant code 037.

### Standard and alternative designs

Motor size	Poles	Standard design		Alternative design
		Deep groove ball bearings		Deep groove ball bearings
		D-end	N-end	Roller bearings (VC037)
		D-end		D-end
71	2 - 6	6203-2Z/C3	6202-2Z/C3	
80	2 - 6	6204-2Z/C3	6203-2Z/C3	
90	2 - 6	6205-2Z/C3	6204-2Z/C3	
100	2 - 6	6206-2Z/C3	6205-2Z/C3	
112	2 - 6	6206-2Z/C3	6205-2Z/C3	
132	2 - 4	6208-2Z/C3	6208-2Z/C3	NU 208 ECP/C3
160	2 - 6	6209-2Z/C3	6209-2Z/C3	NU 209 ECP/C3
180	2 - 6	6210-2Z/C3	6209-2Z/C3	NU 210 ECP/C3
200	2 - 6	6212-2Z/C3	6209-2Z/C3	NU 212 ECP/C3
225	2 - 6	6213-2Z/C3	6210-2Z/C3	NU 213 ECP/C3
250	2 - 6	6215-2Z/C3	6212-2Z/C3	NU 215 ECP/C3
280	2 - 6	6217/C3	6217/C3	NU 217 ECP/C3
315	2	6217/C3	6217/C3	NU 217 ECP/C3
315	4 - 6	6219/C3	6217/C3	NU 219 ECP/C3
355	2	6219/C3	6219/C3	NU 219 ECP/C3
355	4 - 6	6222/C3	6219/C3	NU 222 ECP/C3

### Axially-locked bearings

All motors are equipped as standard with an axially locked bearing at the D-end.



# Mechanical design

## Radial forces

### Permissible loading on the shaft

The following table shows permissible radial forces on the shaft in Newtons, assuming zero axial force, a 25 °C ambient temperature, and normal conditions. The values are given for a calculated bearing life of 20 000 and 40 000 hours per motor size.

These calculated values further assume mounting position IM B3 (foot-mounted), with force directed sideways. In some cases, the strength of the shaft affects permissible forces.

Permissible loads of simultaneous radial and axial forces can be supplied on request.

If the radial force is applied between points X0 and Xmax, the permissible force  $F_R$  can be calculated with the following formula:

$$F_R = F_{X0} - \frac{X}{E} (F_{X0} - F_{Xmax})$$

---

**Where:**

E: length of the shaft extension in the standard version

---

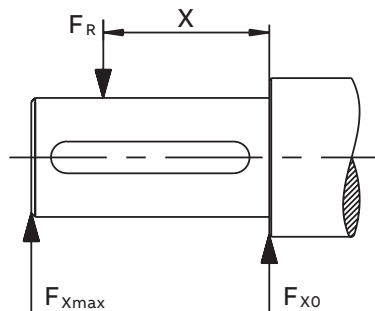

**Permissible radial forces**

Motor size	Poles	Length of shaft extension E (mm)	Basic design with deep groove ball bearings				Basic design with deep groove roller bearings			
			20,000 h		40,000 h		20,000 h		40,000 h	
			$F_{x0}$ (N)	$F_{xmax}$ (N)	$F_{x0}$ (N)	$F_{xmax}$ (N)	$F_{x0}$ (N)	$F_{xmax}$ (N)	$F_{x0}$ (N)	$F_{xmax}$ (N)
71	2	30	545	465	430	370				
	4	30	685	585	545	465				
	6	30	785	660	620	530				
80	2	40	740	620	585	490				
	4	40	925	775	730	615				
	6	40	1065	890	840	705				
90S	2	50	795	645	625	510				
	4	50	1000	815	790	645				
	6	50	1145	935	905	740				
90L	2	50	795	660	630	520				
	4	50	1005	830	790	655				
	6	50	1150	950	910	750				
100	2	60	1110	895	875	705				
	4	60	1395	1120	1100	885				
	6	60	1605	1290	1265	1020				
112	2	60	1120	925	885	730				
	4	60	1405	1160	1105	915				
	6	60	1615	1335	1275	1050				
132S	2	80	1630	1270	1285	1000				
	4	80	2055	1600	1620	1260				
	6	80	2360	1840	1860	1450				
132M	4	80	2075	1665	1630	1310				
	6	80	2375	1905	1865	1495				
160	2	110	1945	1510	1545	1195				
	4	110	2455	1905	1945	1510				
	6	110	2835	2250	2245	1780				
180	2	110	2095	1705	1660	1350				
	4	110	2640	2145	2090	1700				
	6	110	3025	2460	2395	1950				
200	2	110	2800	2350	2200	1830				
	4	110	3550	2910	2810	2305				
	6	110	4065	3335	3220	2640				
225	2	110	3335	2795	2640	2215				
	4	140	4200	3370	3325	2670				
	6	140	4810	3860	2805	3055				
250	2	140	3965	3220	3140	2550				
	4	140	4995	4060	3995	3215				
	6	140	5715	4645	4525	3675				
280	2	140	4900	4050	3850	3200	14750	6850	12000	6850
	4	140	6150	5100	4850	4050	18200	11200	14750	11200
	6	140	7050	5850	5550	4600	20550	11200	16650	11200
315	2	140	4900	4150	3850	3250	14900	6650	12100	6650
	4	170	8000	6650	6350	5250	21200	10350	17200	10350
	6	170	9150	7550	7200	5950	23900	10250	19400	10250
355	2	140	6250	5500	4900	4300	17200	7850	13950	7850
	4	210	10500	8700	8250	6800	28050	16250	22750	16250
	6	210	12000	9900	9400	7750	31650	16200	25700	16200

# Mechanical design

## Axial forces

01 Mounting arrangement IM B3.

02 Mounting arrangement IM V1.

The following tables present permissible axial forces on the shaft in Newtons, assuming zero radial force, a 25 °C ambient temperature, and normal conditions. The values are given for a calculated bearing life of 20,000 and 40,000 hours per motor size.

At 60 Hz, the values must be reduced by 10 percent, and for two-speed motors, the higher speed determines permissible axial force. Permissible loads of simultaneous radial and axial forces can be supplied on request.

For axial force  $F_{AD}$ , it is assumed that the D-bearing is locked with a locking ring.

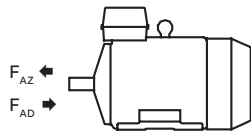

01

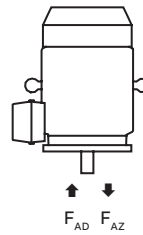

02

### Permissible axial forces

Motor size	Poles	Length of shaft extension E (mm)	Mounting arrangement IM B3				Mounting arrangement IM V1			
			Deep groove ball bearings				Deep groove ball bearings			
			20,000 h		40,000 h		20,000 h		40,000 h	
			$F_{AD}$ (N)	$F_{AZ}$ (N)	$F_{AD}$ (N)	$F_{AZ}$ (N)	$F_{AD}$ (N)	$F_{AZ}$ (N)	$F_{AD}$ (N)	$F_{AZ}$ (N)
71	2	30	580	300	465	185				
	4	30	725	445	580	300				
	6	30	810	530	670	390				
80	2	40	750	430	595	275				
	4	40	940	620	750	430				
	6	40	1055	735	870	550				
90	2	50	845	445	675	275				
	4	50	1050	650	840	440				
	6	50	1175	775	935	535				
100	2	60	1175	615	940	380				
	4	60	1465	905	1175	615				
	6	60	1640	1080	1305	745				
112	2	60	1175	615	935	375				
	4	60	1460	900	1170	610				
	6	60	1635	1075	1300	740				

**Permissible axial forces**

Motor size	Poles	Length of shaft extension E (mm)	Mounting arrangement IM B3				Mounting arrangement IM V1			
			Deep groove ball bearings				Deep groove ball bearings			
			20,000 h		40,000 h		20,000 h		40,000 h	
			$F_{AD}(N)$	$F_{AZ}(N)$	$F_{AD}(N)$	$F_{AZ}(N)$	$F_{AD}(N)$	$F_{AZ}(N)$	$F_{AD}(N)$	$F_{AZ}(N)$
132	2	80	1750	950	1400	600	1900	850	1550	500
	4	80	2200	1400	1750	950	2400	1250	1950	800
160	2	110	1750	1050	1400	700	2050	800	1700	400
	4	110	2200	1500	1700	1050	2650	1150	2200	650
	6	110	2550	1850	2000	1300	2950	1500	2400	950
180	2	110	1800	1100	1450	750	2300	800	1900	400
	4	110	2300	1600	1750	1100	2950	1100	2450	600
	6	110	2650	2000	2050	1400	3300	1550	2700	950
200	2	110	2300	1600	1800	1100	2950	1150	2400	650
	4	110	2950	2300	2300	1600	3850	1650	3200	1000
	6	110	3450	2750	2600	1950	4450	2000	3600	1200
225	2	110	2500	2100	1900	1500	3250	1600	2650	1000
	4	140	3250	2850	2450	2050	4150	2150	3350	1350
	6	140	3800	3400	2850	2500	5000	2650	4050	1700
250	2	140	2950	2450	2250	1750	3950	1800	3200	1100
	4	140	3850	3350	2950	2400	5100	2550	4150	1600
	6	140	4500	3950	3400	2850	6100	2900	5000	1750
280	2	140	4350	2350	3450	1450	5750	1350	4850	450
	4	140	5400	3400	4250	2250	7400	2100	6200	900
	6	140	6200	4200	4850	2850	8300	2650	6900	1250
315	2	140	4150	2150	3300	1300	6100	450	-	-
	4	170	6600	4600	5100	3100	9250	2300	7700	750
	6	170	7550	5550	5800	3800	10850	2600	9050	750
355	2	140	4900	3200	3800	2100	8300	600	-	-
	4	210	8050	6300	6100	4350	12750	2700	10750	700
	6	210	9250	7500	6950	5200	14650	2950	12300	600

# Terminal box

## Standard terminal box

01 Terminal box for sizes 71 to 132.

02 Terminal box for sizes 160 to 180.

03 Terminal box for sizes 200 to 250.

04 Terminal box for sizes 280 to 355.

05 Terminal board for sizes 71 to 132.

06 Terminal board for sizes 160 to 180.

07 Terminal board for sizes 200 to 250.

08 Terminal board for sizes 280 to 355.

### Terminal boxes

The pictures below show standard terminal boxes.

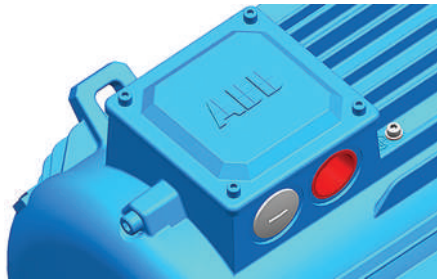

01

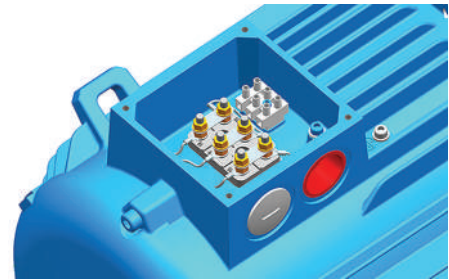

05



02

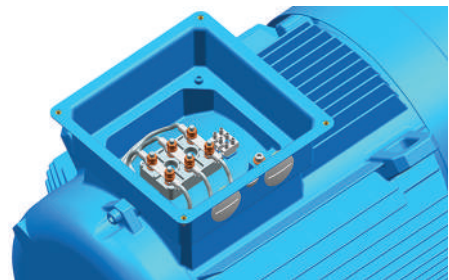

06



03



07



04



08

# Dimension drawings

## General performance IE2 cast iron motors

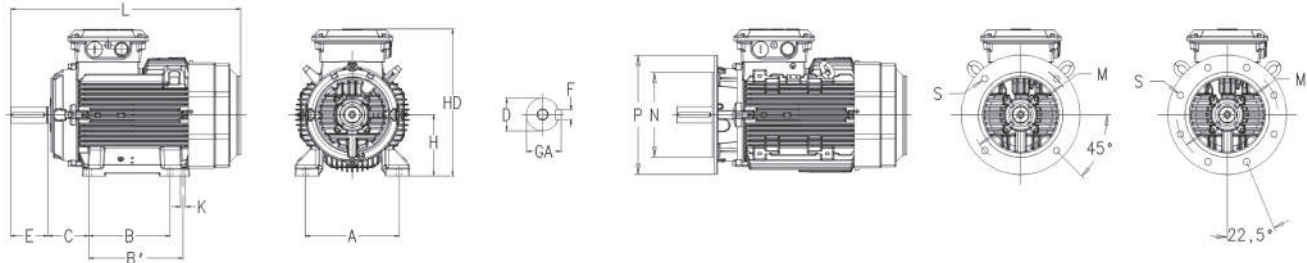

### Foot-mounted motor IM1001, B3 and flange-mounted motor IM3001, B5

Motor size	D poles		GA poles		F poles		E poles		L max poles		A	B	B'	C	HD max	K	M	N	P	S
	2	4-8	2	4-8	2	4-8	2	4-8	2	4-8										
71M	14	14	16	16	5	5	30	30	257	257	112	90	-	45	175	7	130	110	160	10
71ML	14	14	16	16	5	5	30	30	282	282	112	90	-	45	175	7	130	110	160	10
80M	19	19	21.5	21.5	6	6	40	40	309	309	125	100	-	50	192	10	165	130	200	12
80ML	19	19	21.5	21.5	6	6	40	40	334	334	125	100	112	50	192	10	165	130	200	12
90S	24	24	27	27	8	8	50	50	335	335	140	100	-	56	217	10	165	130	200	12
90SL	24	24	27	27	8	8	50	50	351	351	140	100	125	56	217	10	165	130	200	12
90L <sup>1)</sup>	24	24	27	27	8	8	50	50	351	351	140	125	-	56	217	10	165	130	200	12
100L	28	28	31	31	8	8	60	60	376	376	160	140	-	63	240	12	215	180	250	14.5
100LK	28	28	31	31	8	8	60	60	411	411	160	140	160	63	240	12	215	180	250	14.5
112M	28	28	31	31	8	8	60	60	411	411	190	140	-	70	252	12	215	180	250	14.5
112ML	28	28	31	31	8	8	60	60	456	456	190	140	159	70	252	12	215	180	250	14.5
132S	38	38	41	41	10	10	80	80	479	479	216	140	-	89	302	12	265	230	300	14.5
132SM	38	38	41	41	10	10	80	80	521	521	216	140	178	89	302	12	265	230	300	14.5
132M	38	38	41	41	10	10	80	80	521	521	216	178	-	89	302	12	265	230	300	14.5
132ML	38	38	41	41	10	10	80	80	586	586	216	178	203	89	302	12	265	230	300	14.5
160 <sup>1)</sup>	42	42	45	45	12	12	110	110	639	639	254	210	254	108	414	14.5	300	250	350	18.5
160 <sup>2)</sup>	42	42	45	45	12	12	110	110	696	696	254	210	254	108	414	14.5	300	250	350	18.5
180	48	48	51.5	51.5	14	14	110	110	728	728	279	241	279	121	454	14.5	300	250	350	18.5
200	55	55	59	59	16	16	110	110	809	809	318	267	305	133	515	18.5	350	300	400	18.5
225	55	60	59	64	16	18	110	140	812	842	356	286	311	149	560	18.5	400	350	450	18.5
250	60	65	64	69	18	18	140	140	853	853	406	311	349	168	613	24	500	450	550	18.5
280	65	75	69	79.5	18	20	140	140	1012	1012	457	368	419	190	710	24	500	450	550	18.5
315 SM_	65	80	69	85	18	22	140	170	1216	1246	508	406	457	216	849	28	600	550	660	24
315 ML_	65	90	69	95	18	25	140	170	1326	1356	508	457	508	216	849	28	600	550	660	24
355 SM_	70	100	74.5	106	20	28	140	210	1399	1469	610	500	560	254	933	35	740	680	800	24

<sup>1)</sup> MLA 2-6, MLB2

<sup>2)</sup> MLC, MLB4-6

### IMB14 (IM3601)

Motor size	M	N	P	S	T
71	85	70	105	6	2.5
80	100	80	120	6	3
90	115	95	140	8	3
100	130	110	160	8	3.5
112	130	110	160	8	3.5
132	165	130	200	10	3.5

# Dimension drawings

## General performance IE3 cast iron motors

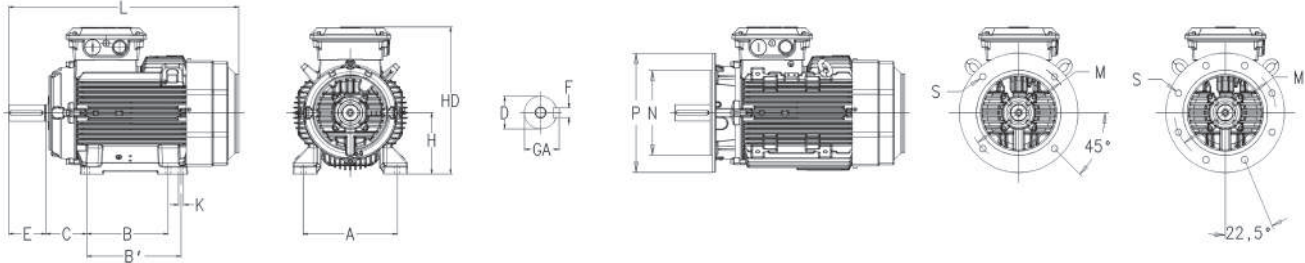

Foot-mounted motor IM1001, B3 and flange-mounted motor IM3001, B5

Motor size	D poles		GA poles		F poles		E poles		L max poles		A	B	B'	C	HD max	K	M	N	P	S
	2	4-8	2	4-8	2	4-8	2	4-8	2	4-8										
71M	14	14	16	16	5	5	30	30	257	257	112	90	-	45	175	7	130	110	160	10
71ML	14	14	16	16	5	5	30	30	282	282	112	90	-	45	175	7	130	110	160	10
80M	19	19	21.5	21.5	6	6	40	40	309	309	125	100	-	50	192	10	165	130	200	12
80ML	19	19	21.5	21.5	6	6	40	40	334	334	125	100	112	50	192	10	165	130	200	12
90S	24	24	27	27	8	8	50	50	335	335	140	100	-	56	217	10	165	130	200	12
90SL	24	24	27	27	8	8	50	50	351	351	140	100	125	56	217	10	165	130	200	12
90L_	24	24	27	27	8	8	50	50	386	386	140	125	-	56	217	10	165	130	200	12
100L_	28	28	31	31	8	8	60	60	376	376	160	140	-	63	240	12	215	180	250	14.5
100LK_	28	28	31	31	8	8	60	60	411	411	160	140	160	63	240	12	215	180	250	14.5
112M_	28	28	31	31	8	8	60	60	411	411	190	140	-	70	252	12	215	180	250	14.5
112ML_	28	28	31	31	8	8	60	60	456	456	190	140	159	70	252	12	215	180	250	14.5
132S_	38	38	41	41	10	10	80	80	521	521	216	178	-	89	302	12	265	230	300	14.5
132M_	38	38	41	41	10	10	80	80	586	586	216	178	203	89	302	12	265	230	300	14.5
160 MLA 2	42	42	45	45	12	12	110	110	587	587	254	210	254	108	413	14.5	300	250	350	18.5
160 MLB 2	42	42	45	45	12	12	110	110	587	587	254	210	254	108	413	14.5	300	250	350	18.5
160 MLA 4	42	42	45	45	12	12	110	110	627	627	254	210	254	108	413	14.5	300	250	350	18.5
160 MLA 6	42	42	45	45	12	12	110	110	627	627	254	210	254	108	413	14.5	300	250	350	18.5
160 MLC 2	42	42	45	45	12	12	110	110	684	684	254	210	254	108	413	14.5	300	250	350	18.5
160 MLB 4	42	42	45	45	12	12	110	110	684	684	254	210	254	108	413	14.5	300	250	350	18.5
160 MLB 6	42	42	45	45	12	12	110	110	684	684	254	210	254	108	413	14.5	300	250	350	18.5
180 MLA2	48	48	51.5	51.5	14	14	110	110	684	684	279	241	279	121	434	14.5	300	250	350	18.5
180 MLA4	48	48	51.5	51.5	14	14	110	110	684	684	279	241	279	121	434	14.5	300	250	350	18.5
180 MLA6	48	48	51.5	51.5	14	14	110	110	744	744	279	241	279	121	434	14.5	300	250	350	18.5
180 MLB4	48	48	51.5	51.5	14	14	110	110	744	744	279	241	279	121	434	14.5	300	250	350	18.5
200 MLA6	55	55	59	59	16	16	110	110	728	728	318	267	305	133	473	18.5	350	300	400	18.5
200 MLA2	55	55	59	59	16	16	110	110	828	828	318	267	305	133	473	18.5	350	300	400	18.5
200 MLA4	55	55	59	59	16	16	110	110	828	828	318	267	305	133	473	18.5	350	300	400	18.5
200 MLB2	55	55	59	59	16	16	110	110	828	828	318	267	305	133	473	18.5	350	300	400	18.5
200 MLB6	55	55	59	59	16	16	110	110	828	828	318	267	305	133	473	18.5	350	300	400	18.5
225 SMA2	55	55	59	59	16	16	110	110	854	854	356	286	311	149	539	18.5	400	350	450	18.5
225 SMA4	55	55	59	59	16	16	110	110	812	812	356	286	311	149	539	18.5	400	350	450	18.5
225 SMA6	55	55	59	59	16	16	110	110	812	812	356	286	311	149	539	18.5	400	350	450	18.5
225 SMB4	55	55	59	59	16	16	110	110	812	812	356	286	311	149	539	18.5	400	350	450	18.5
250 SMA2	60	60	64	64	18	18	140	140	882	882	406	311	349	168	585	24	500	450	550	18.5
250 SMA4	60	60	64	64	18	18	140	140	927	927	406	311	349	168	585	24	500	450	550	18.5
250 SMA6	60	60	64	64	18	18	140	140	927	927	406	311	349	168	585	24	500	450	550	18.5
280	65	75	69	79.5	18	20	140	140	1052	1052	457	368	419	190	775	24	500	450	550	18.5
315 SM_	65	80	69	85	18	22	140	170	1216	1246	508	406	457	216	849	28	600	550	660	24
315 ML_	65	90	69	95	18	25	140	170	1326	1356	508	457	508	216	849	28	600	550	660	24
355 SM_	70	100	74.5	106	20	28	140	210	1399	1469	610	500	560	254	933	35	740	680	800	24

**IMB14 (IM3601)**

<b>Motor size</b>	<b>M</b>	<b>N</b>	<b>P</b>	<b>S</b>	<b>T</b>
71	85	70	105	6	2.5
80	100	80	120	6	3
90	115	95	140	8	3
100	130	110	160	8	3.5
112	130	110	160	8	3.5
132	165	130	200	10	3.5



# Motors in brief

## Cast iron motors, sizes 71 - 112

Motor size	M2BAX	71	80	90	100	112
Stator and end shields	Material	Cast iron				
	Paint color shade	Munsell blue 8B 4.5/3.25				
	Corrosion class	C3 medium				
Feet	Material	Integrated cast iron				
Bearings	D-end	6203-2Z/C3	6204-2Z/C3	6205-2Z/C3	6206-2Z/C3	6206-2Z/C3
	N-end	6202-2Z/C3	6203-2Z/C3	6204-2Z/C3	6205-2Z/C3	6205-2Z/C3
Axially locked bearings		Locked at D-end with retaining ring				
Bearing seals	D-end	V-ring				
	N-end	V-ring				
Lubrication		Permanently lubricated shielded bearings				
Measuring nipples for condition monitoring of the bearings		Not Included				
Rating plate	Material	Stainless steel				
Terminal box	Material	Steel				
	Corrosion class	C3 medium				
	Cover screws	Zinc-electroplated steel				
Connections	Threaded openings	2xM16, 1xM16	2xM25, 1xM16		2xM32, 1xM16	
	Max Cu-area mm	4	6		10	
	Terminals	6 terminals for connection with cable lugs (not included)				
	Cable glands	Glands as option				
Fan	Material	Glass-fiber reinforced polypropylene				
Fan cover	Material	Steel				
	Paint color shade	Munsell blue 8B 4.5/3.25				
	Corrosion class	C3 medium				
Stator winding	Material	Copper				
	Insulation	Insulation class F. Temperature rise class B unless otherwise stated.				
	Winding protection	3 PTC thermistors, 150°C				
Rotor winding	Material	Pressure die-cast aluminum				
Balancing method		Half key balancing as standard				
Key ways		Open key way				
Drain holes		Drain holes with closable plastic plugs, open on delivery				
Enclosure		IP 55 Higher protection on request				
Cooling method		IC 411				
Lifting lugs		Integrated cast iron lifting lugs				

# Motors in brief

## Cast iron motors, sizes 132 - 250

Motor size	M2BAX	132	160	180	200	225	250
Stator and end shields	Material	Cast iron					
	Paint color shade	Munsell blue 8B 4.5/3.25					
	Corrosion class	C3 (medium)					
Feet	Material	Integrated cast iron feet					
Bearings	D-end	6208-2Z/C3	6209-2Z/C3	6210-2Z/C3	6212/C3	6213-2Z/C3	6215-2Z/C3
	N-end	6208-2Z/C3	6209-2Z/C3	6209-2Z/C3	6209-2Z/C3	6210-2Z/C3	6212-2Z/C3
Axially locked bearings		Locked at D-end with retaining ring	Locked at D-end with inner bearing cover				
Bearing seals	D-end	V-ring					
	N-end	V-ring					
Lubrication		Permanently lubricated shielded bearings					
Measuring nipples for condition monitoring of the bearings		Not Included					
Rating plate	Material	Stainless steel					
Terminal box	Material	Steel					
	Corrosion class	C3 (medium)					
	Cover screws	Zinc-electroplated steel					
Connections	Threaded openings	2xM32	2xM40, 1xM16		2xM63, 1xM16		
	Terminals	6 terminals for connection with cable lugs (not included)					
	Cable glands	Glands as option		Cable flange included, glands as option			
Fan	Material	Glass-fiber reinforced polypropylene					
Fan cover	Material	Steel					
	Paint color shade	Munsell blue 8B 4.5/3.25					
	Corrosion class	C3 (medium)					
Stator winding	Material	Copper					
	Insulation	Insulation class F. Temperature rise class B unless otherwise stated.					
	Winding protection	3 PTC thermistors, 150 °C					
Rotor winding	Material	Pressure die-cast aluminum					
Balancing method		Half-key balancing as standard					
Key ways		Open key way					
Drain holes		Drain holes with closable plastic plugs, open on delivery					
Enclosure		IP 55 Higher protection on request					
Cooling method		IC 411					
Lifting lugs		Integrated cast iron lifting lug					

# Motors in brief

## Cast iron motors, sizes 280 - 355

Motor size	M2BAX	280	315	355
Stator and end shields	Material	Cast iron		
	Paint color shade	Munsell blue 8B 4.5/3.25		
	Corrosion class	C3 medium		
Feet		Integrated cast iron		
Bearings	D-end 2-pole	6217/C3	6217/C3	6219/C3
	D-end 4-6 -pole	6217/C3	6219/C3	6222/C3
	N-end 2-pole	6217/C3	6217/C3	6219/C3
	N-end 4-6 -pole	6217/C3	6217/C3	6219/C3
Axially locked bearings		Locked at D-end with inner bearing cover		
Bearing seals	D-end	V-ring		
	N-end	V-ring		
Lubrication		Regreasable bearings, regreasing nipples M6x1		
Measuring nipples for condition monitoring of the bearings		Not included		
Rating plate	Material	Stainless steel		
Terminal box	Material frame	Cast iron		
	Cover	Cast iron terminal box cover		
	Corrosion class	C3 medium		
	Screws	Zinc-electroplated steel		
Connections	Threaded openings	2xM63, 2 x M20	2xM63, 2 x M20	2xM75, 2 x M20
	Terminals	6 terminals for connection with cable lugs (not included)		
	Cable glands	Cable glands as option		
Fan	Material	Glass-fiber reinforced polypypropylene / 2-pole metal.		
Fan cover	Material	Steel fan cover		
	Paint color shade	Black / Munsell blue 8B 4.5/3.25		
	Corrosion class	C3 medium		
Stator winding	Material	Copper		
	Insulation	Insulation class F. Temperature rise class B unless otherwise stated.		
	Winding protection	3 PTC thermistors, 150 °C		
Rotor winding	Material	Pressure diecast aluminum		
Balancing method		Half key balancing as standard		
Keyway		Open key way		
Heating elements	On request	60 W	2x60 W	2x60 W
Enclosure		IP 55 Higher protection on request		
Cooling method		IC 411		
Drain holes		Drain holes with closable plastic plugs, open on delivery		
Lifting lugs		Bolted lifting lugs		



# General performance aluminum motors

Sizes 56 to 250, 0.06 to 55 kW

<b>38</b>	<b>Ordering information</b>
<b>39</b>	<b>Technical data IE1</b>
39	3000 r/min motors
40	1500 r/min motors
41	1000 r/min motors
<b>42</b>	<b>Technical data IE2</b>
42	3000 r/min motors
43	1500 r/min motors
44	1000 r/min motors
<b>45</b>	<b>Variant codes</b>
<b>47</b>	<b>Dimension drawings</b>
<b>48</b>	<b>Motors in brief</b>
48	Motor sizes 56 - 132
49	Motor sizes 160 - 250

# Ordering information

## Explanation of the product code

Motor type	Motor size	Product code	Mounting arrangement code, Voltage and frequency code, Generation code	Variant codes
M2AA	112MB	3GAA 113	212 - ADE	112, etc.
		1 2 3 4 5 6 7	8 9 10 11 12 13 14	

### Positions 1 to 4

3GAA: : Totally enclosed motor with aluminum stator frame

### Positions 5 and 6

IEC size

05:	56
06:	63
07:	71
08:	80
09:	90
10:	100
11:	112
13:	132
16:	160
18:	180
20:	200
22:	225
25:	250

### Position 7

Pole pairs

1:	2 poles
2:	4 poles
3:	6 poles

### Positions 8 to 10

Running number

### Position 11

- (dash)

### Position 12

Mounting arrangement

A:	Foot-mounted motor
B:	Flange-mounted motor. Large flange with clearance holes.
C:	Flange-mounted motor. Small flange with tapped holes.
F:	Foot- and flange-mounted motor. Special flange.
H:	Foot- and flange-mounted motor. Large flange with clearance holes.
J:	Foot- and flange-mounted motor. Small flange with tapped holes.
N:	Flange-mounted (CI ring flange FF)
P:	Foot- and flange-mounted motor (CI ring flange FF)

### Position 13

Voltage and frequency

Single-speed motors

D:	400 VΔ, 415 VΔ, 460 VΔ, 690 VY 50 Hz
S:	230 VΔ, 400 VY, 415 VY 50 Hz, 460 VΔ 60 Hz*)

### Position 14

Version A, B, C... = Generation code followed by variant codes

\*) M2AA 200 is not available for voltages less than 380 VD

Efficiency values are given according to IEC 60034-2-1; 2014

For detailed dimension drawings please see our web-pages 'www.abb.com/motors&generators' or contact ABB.

# Technical data

## IE1 aluminum motors

IP 55 - IC 411 - Insulation class F, temperature rise class B  
IE1 efficiency class according to IEC 60034-30-1; 2014

Output kW	Motor type	Product code	Speed r/min	Efficiency IEC 60034-30-1; 2014			Power factor Cosφ	Current		Torque		Moment of inertia J = 1/4 GD <sup>2</sup> kgm <sup>2</sup>	Weight kg	Sound pressure Level L <sub>PA</sub> dB	
				Full load 100%	3/4 load 75%	1/2 load 50%		I <sub>N</sub> A	I <sub>s</sub> /I <sub>N</sub>	T <sub>N</sub> Nm	T <sub>i</sub> /T <sub>N</sub>				T <sub>b</sub> /T <sub>N</sub>
<b>3000 r/min = 2 poles</b>				<b>400 V 50 Hz</b>				<b>CENELEC-design</b>							
0.09	M2AA 56A 2	3GAA051001-...E	2800	55,6	50,8	38,7	0,67	0,35	3,5	0,29	2,4	2,6	0,0001	2,6	56
0.12	M2AA 56B 2	3GAA051002-...E	2830	61,8	58,3	48,3	0,68	0,41	4,3	0,4	2,5	2,8	0,00013	3	57
0.18	M2AA 63A 2	3GAA061001-...E	2790	67,3	65,1	58,2	0,75	0,51	4,5	0,61	2,4	2,6	0,00015	4	60
0.25	M2AA 63B 2	3GAA061002-...E	2790	71,4	70,1	64,7	0,76	0,66	4,8	0,86	2,8	2,7	0,00017	4,2	61
0.37	<sup>1)</sup> M2AA 71A 2	3GAA071001-...E	2800	73,8	75,8	73,9	0,76	0,95	4,9	1,26	2,7	2,7	0,00035	4,9	58
0.55	<sup>1)</sup> M2AA 71B 2	3GAA071002-...E	2790	78,4	79,8	78,7	0,78	1,29	5,3	1,88	2,9	2,8	0,00045	5,9	58
0.75	<sup>1)</sup> M2AA 80A 2	3GAA081001-...E	2815	76,8	78,9	77,4	0,8	1,76	5	2,5	3	3	0,00069	8,5	60
1.1	<sup>1)</sup> M2AA 80B 2	3GAA081002-...E	2785	76,8	79,3	78	0,81	2,5	5,7	3,7	2,7	2,8	0,0009	10,5	60
1.5	<sup>1)</sup> M2AA 90S 2	3GAA091001-...E	2895	78,5	77,2	71,6	0,75	3,6	6,4	4,9	2,3	3	0,0019	13	63
2.2	M2AA 90L 2	3GAA091002-...E	2890	82,6	84,4	83,7	0,84	4,5	7	7,2	2,5	2,7	0,0024	16	63
3	M2AA 100L 2	3GAA101001-...E	2905	84,5	84,9	83,4	0,84	6,1	7,5	9,8	2,5	3,2	0,0041	21	65
4	<sup>1)</sup> M2AA 112M 2	3GAA111101-...E	2885	85,7	86,7	86,5	0,85	7,9	7,4	13,2	2,6	2,8	0,0061	26	67
5.5	M2AA 132SA 2	3GAA131001-...E	2845	85,8	86,4	86	0,87	10,6	6,8	18,4	2,8	3,2	0,014	38	75
7.5	<sup>1)</sup> M2AA 132SB 2	3GAA131002-...E	2860	87	88	86	0,89	13,9	7,2	25	3	3,4	0,016	43	73

<sup>1)</sup> Temperature rise class F

Output kW	Motor type	Product code	Speed r/min	Efficiency IEC 60034-30-1; 2014			Power factor Cosφ	Current		Torque		Moment of inertia J = 1/4 GD <sup>2</sup> kgm <sup>2</sup>	Weight kg	Sound pressure Level L <sub>PA</sub> dB	
				Full load 100%	3/4 load 75%	1/2 load 50%		I <sub>N</sub> A	I <sub>s</sub> /I <sub>N</sub>	T <sub>N</sub> Nm	T <sub>i</sub> /T <sub>N</sub>				T <sub>b</sub> /T <sub>N</sub>
<b>3000 r/min = 2 poles</b>				<b>400 V 50 Hz</b>				<b>High-output design</b>							
11	<sup>1)</sup> M2AA 132SMA 2	3GAA131005-...E	2890	89	90,4	90,6	0,87	20,5	7,5	36,3	2,5	3,1	0,0165	63	69
15	<sup>1)</sup> M2AA 132SMC 2	3GAA131006-...E	2905	89,9	90,2	89,3	0,87	27,6	9,1	49,3	3,3	4	0,02	81	69
18.5	M2AA 132SMD 2	3GAA131007-...E	2870	89,3	90,5	90,7	0,88	33,9	8,2	61,5	2,9	3,5	0,0236	89	68

<sup>1)</sup> Temperature rise class F

# Technical data

## IE1 aluminum motors

IP 55 - IC 411 - Insulation class F, temperature rise class B  
IE1 efficiency class according to IEC 60034-30-1; 2014

Output kW	Motor type	Product code	Speed r/min	Efficiency IEC 60034-30-1; 2014			Power factor Cosφ	Current		Torque			Moment of inertia J = 1/4 GD <sup>2</sup> kgm <sup>2</sup>	Weight kg	Sound pressure Level L <sub>PA</sub> dB
				Full load 100%	3/4 load 75%	1/2 load 50%		I <sub>N</sub> A	I <sub>s</sub> /I <sub>N</sub>	T <sub>N</sub> Nm	T <sub>i</sub> /T <sub>N</sub>	T <sub>b</sub> /T <sub>N</sub>			
<b>1500 r/min = 4 poles</b>				<b>400 V 50 Hz</b>				<b>CENELEC-design</b>							
0.06	M2AA 56A 4	3GAA052001-...E	1390	52,8	49,6	40,8	0,54	0,3	3,2	0,41	3,2	3,3	0,00019	2,9	47
0.09	M2AA 56B 4	3GAA052002-...E	1400	56,2	52,6	44,8	0,59	0,39	3,1	0,62	2,3	2,8	0,00024	3,2	48
0.12	M2AA 63A 4	3GAA062001-...E	1360	55	51,3	43	0,64	0,49	3,2	0,84	2,4	2,5	0,00027	3,7	51
0.18	M2AA 63B 4	3GAA062002-...E	1370	63,5	61	54,3	0,61	0,67	3,7	1,25	2,8	2,9	0,00034	4,2	54
0.25	M2AA 71A 4	3GAA072001-...E	1365	65,1	66	62,7	0,76	0,72	4	1,74	2	2,1	0,00066	5,2	45
0.37	<sup>1)</sup> M2AA 71B 4	3GAA072002-...E	1375	69,7	71,9	71,1	0,79	0,96	3,8	2,5	2	2,2	0,0008	5,9	45
0.75	<sup>1)</sup> M2AA 80B 4	3GAA082002-...E	1390	73	75,4	73,6	0,73	2	5,1	5,1	2,5	2,6	0,0019	10	50
1.1	M2AA 90S 4	3GAA092001-...E	1420	77,2	78,1	76	0,77	2,6	4,8	7,3	2	2,6	0,0032	13	50
1.5	M2AA 90L 4	3GAA092002-...E	1420	81,3	81,9	80,1	0,75	3,5	5,8	10	2,8	3	0,0043	16	50
2.2	M2AA 100LA 4	3GAA102001-...E	1430	82,3	83,4	82,5	0,78	4,9	5,6	14,6	2,2	2,6	0,0069	21	64
3	M2AA 100LB 4	3GAA102002-...E	1430	84,6	85,7	84,2	0,78	6,5	6,4	20	2,5	3	0,0082	24	66
4	M2AA 112M 4	3GAA112101-...E	1430	83,5	85,1	85	0,83	8,3	6,1	26,8	2,5	3	0,01	29	60
5.5	<sup>1)</sup> M2AA 132S 4	3GAA132001-...E	1450	86,5	87	86,1	0,75	12,2	5,6	36,2	2,1	2,6	0,031	42	66
7.5	<sup>1)</sup> M2AA 132M 4	3GAA132002-...E	1450	88,6	89,2	88,4	0,75	16,2	6,1	49,3	2,3	2,7	0,038	49	66

<sup>1)</sup> Temperature rise class F

Output kW	Motor type	Product code	Speed r/min	Efficiency IEC 60034-30-1; 2014			Power factor Cosφ	Current		Torque			Moment of inertia J = 1/4 GD <sup>2</sup> kgm <sup>2</sup>	Weight kg	Sound pressure Level L <sub>PA</sub> dB
				Full load 100%	3/4 load 75%	1/2 load 50%		I <sub>N</sub> A	I <sub>s</sub> /I <sub>N</sub>	T <sub>N</sub> Nm	T <sub>i</sub> /T <sub>N</sub>	T <sub>b</sub> /T <sub>N</sub>			
<b>1500 r/min = 4 poles</b>				<b>400 V 50 Hz</b>				<b>High-output design</b>							
11	<sup>1)</sup> M2AA 132SMA 4	3GAA132005-E	1460	88,6	89,1	88,1	0,78	22,9	7	71,9	2,1	2,9	0,0381	76	69
15	<sup>1)</sup> M2AA 132SMC 4	3GAA132006-E	1455	89,2	89,7	89,3	0,78	31,1	7,2	98,4	2,4	3,3	0,0485	88	69

<sup>1)</sup> Temperature rise class F



# Technical data

## IE1 aluminum motors

IP 55 - IC 411 - Insulation class F, temperature rise class B  
IE1 efficiency class according to IEC 60034-30-1; 2014

Output kW	Motor type	Product code	Speed r/min	Efficiency IEC 60034-30-1; 2014			Power factor Cosφ	Current		Torque		Moment of inertia J = 1/4 GD <sup>2</sup> kgm <sup>2</sup>	Weight kg	Sound pressure Level L <sub>PA</sub> dB	
				Full load 100%	3/4 load 75%	1/2 load 50%		I <sub>N</sub> A	I <sub>s</sub> /I <sub>N</sub>	T <sub>N</sub> Nm	T <sub>i</sub> /T <sub>N</sub>				T <sub>b</sub> /T <sub>N</sub>
<b>1000 r/min = 6 poles</b>				<b>400 V 50 Hz</b>				<b>CENELEC-design</b>							
0.09	M2AA 63A 6	3GAA063001---E	890	50,7	48,5	42	0,62	0,41	2,8	0,96	2	2,2	0,00042	4,2	48
0.12	M2AA 63B 6	3GAA063002---E	890	52,3	48,8	41,5	0,6	0,55	3	1,29	2,2	2,4	0,00052	4,5	53
0.18	<sup>1)</sup> M2AA 71A 6	3GAA073001---E	885	59,5	61,1	56,5	0,71	0,61	3,1	1,94	1,7	1,9	0,00092	5,5	42
0.25	<sup>1)</sup> M2AA 71B 6	3GAA073002---E	895	64	63,6	59,5	0,71	0,79	3,3	2,6	2,2	2,2	0,0012	6,5	42
0.75	M2AA 90S 6	3GAA093001---E	925	71,5	70,9	65,9	0,64	2,3	3,6	7,7	2,1	2,4	0,0032	13	44
1.1	M2AA 90L 6	3GAA093002---E	915	73	73,4	70	0,63	3,4	3,2	11,4	1,9	2,1	0,0043	16	44
1.5	M2AA 100L 6	3GAA103001---E	950	79,6	79,9	77,5	0,69	3,9	4,2	15	2	2,3	0,0082	23	49
2.2	M2AA 112M 6	3GAA113101---E	950	80,1	80,2	77,5	0,67	5,9	4,6	22,1	2,4	2,8	0,01	28	54
3	<sup>1)</sup> M2AA 132S 6	3GAA133001---E	960	82,5	82,9	80,9	0,68	7,7	4,3	29,8	1,8	2,3	0,031	39	57
4	<sup>1)</sup> M2AA 132MA 6	3GAA133002---E	965	83,6	83,2	80,8	0,65	10,6	5,1	39,5	2,1	2,5	0,038	46	61
5.5	<sup>1)</sup> M2AA 132MB 6	3GAA133003---E	960	83,8	84,3	82,9	0,71	13,3	5,3	54,7	2	2,4	0,045	54	57

<sup>1)</sup>Temperature rise class F

Output kW	Motor type	Product code	Speed r/min	Efficiency IEC 60034-30-1; 2014			Power factor Cosφ	Current		Torque		Moment of inertia J = 1/4 GD <sup>2</sup> kgm <sup>2</sup>	Weight kg	Sound pressure Level L <sub>PA</sub> dB	
				Full load 100%	3/4 load 75%	1/2 load 50%		I <sub>N</sub> A	I <sub>s</sub> /I <sub>N</sub>	T <sub>N</sub> Nm	T <sub>i</sub> /T <sub>N</sub>				T <sub>b</sub> /T <sub>N</sub>
<b>1000 r/min = 6 poles</b>				<b>400 V 50 Hz</b>				<b>High-output design</b>							
7.5	<sup>1)</sup> M2AA 132SMA 6	3GAA133006---E	950	84,7	86,1	86,3	0,73	17,5	4,9	75,3	1,7	2,1	0,0485	88	69

<sup>1)</sup>Temperature rise class F

# Technical data

## IE2 aluminum motors, 3000 r/min

IP 55 - IC 411 - Insulation class F, temperature rise class B  
IE2 efficiency class according to IEC 60034-30-1; 2014

Output kW	Motor type	Product code	Speed r/min	Efficiency IEC 60034-30-1; 2014			Power factor Cosφ	Current		Torque		Moment of inertia J = 1/4 GD <sup>2</sup> kgm <sup>2</sup>	Weight kg	Sound pressure Level L <sub>PA</sub> dB	
				Full load 100%	3/4 load 75%	1/2 load 50%		I <sub>N</sub> A	I <sub>s</sub> /I <sub>N</sub>	T <sub>N</sub> Nm	T <sub>i</sub> /T <sub>N</sub>				T <sub>b</sub> /T <sub>N</sub>
<b>3000 r/min = 2 poles</b>				<b>400 V 50 Hz</b>				<b>CENELEC-design</b>							
0.09	M2AA 56A 2	3GAA051001-...E	2800	55,6	50,8	38,7	0,67	0,35	3,5	0,29	2,4	2,6	0,0001	2,6	56
0.12	M2AA 56B 2	3GAA051002-...E	2830	61,8	58,3	48,3	0,68	0,41	4,3	0,4	2,5	2,8	0,00013	3	57
0.18	M2AA 63A 2	3GAA061001-...E	2790	67,3	65,1	58,2	0,75	0,51	4,5	0,61	2,4	2,6	0,00015	4	60
0.25	M2AA 63B 2	3GAA061002-...E	2790	71,4	70,1	64,7	0,76	0,66	4,8	0,86	2,8	2,7	0,00017	4,2	61
0.37	<sup>1)</sup> M2AA 71A 2	3GAA071001-...E	2800	73,8	75,8	73,9	0,76	0,95	4,9	1,26	2,7	2,7	0,00035	4,9	58
0.55	<sup>1)</sup> M2AA 71B 2	3GAA071002-...E	2790	78,4	79,8	78,7	0,78	1,29	5,3	1,88	2,9	2,8	0,00045	5,9	58
0.75	M2AA 80B 2	3GAA081212-...E	2895	80,6	80,4	77,3	0,79	1,7	8,1	2,4	3,7	3,9	0,0009	10,5	60
1.1	M2AA 80C 2	3GAA081213-...E	2875	80,6	80,4	77,9	0,80	2,4	7,8	3,6	3,6	3,5	0,0012	11	60
1.5	M2AA 90L 2	3GAA091212-...E	2900	84,1	85,0	83,5	0,86	2,9	7,6	4,9	2,5	3,3	0,0024	16	60
2.2	M2AA 90LB 2	3GAA091213-...E	2875	84,6	85,7	85,5	0,85	4,4	6,9	7,3	2,8	3,2	0,0027	18	63
3	M2AA 100LB 2	3GAA101212-...E	2920	86,4	86,0	83,9	0,86	5,8	9,3	9,8	3,3	3,9	0,005	25	62
4	M2AA 112MB 2	3GAA111212-...E	2885	86,1	87,0	88,0	0,88	7,6	7,6	13,2	2,5	2,8	0,0062	30	68
5.5	M2AA 132SB 2	3GAA131212-...E	2915	88,0	88,5	87,6	0,82	11	7,9	18	2,6	3,6	0,016	42	73
7.5	M2AA 132SC 2	3GAA131213-...E	2915	88,5	89,2	88,6	0,88	13,6	7,6	24,5	2,2	3,2	0,022	56	73
11	M2AA 160MLA 2	3GAA161410-...F	2920	89,8	90,2	89,8	0,89	19,8	5,9	35,9	1,6	2,7	0,038	83	69
15	M2AA 160MLB 2	3GAA161420-...F	2934	91,1	90,6	90,0	0,90	26,4	7,0	48,8	2,5	3,1	0,048	96	69
18.5	M2AA 160MLC 2	3GAA161430-...F	2934	90,9	90,4	89,3	0,89	32,9	7,3	60,2	2,6	3,2	0,052	104	73
22	M2AA 180MLA 2	3GAA181410-...F	2933	91,5	92,2	91,9	0,90	38,1	7,8	71,6	3,0	3,5	0,062	123	73
30	M2AA 200MLA 2	3GAA201410-...F	2948	92,2	91,9	91,3	0,89	52,7	7,8	97,1	2,7	3,3	0,092	160	75
37	<sup>1)</sup> M2AA 200MLB 2	3GAA201420-...F	2947	92,5	93,0	92,7	0,90	64,3	7,7	119	2,8	3,6	0,116	186	75
45	M2AA 225SMA 2	3GAA221210-...F	2960	93,0	93,6	92,8	0,90	79,2	8,1	145	3,1	3,4	0,197	244	75
55	M2AA 250SMA 2	3GAA251210-...F	2963	93,9	94,4	93,7	0,89	94,4	6,8	177	2,6	2,5	0,275	308	75

<sup>1)</sup> Temperature rise class F

# Technical data

## IE2 aluminum motors, 1500 r/min

IP 55 - IC 411 - Insulation class F, temperature rise class B  
IE2 efficiency class according to IEC 60034-30-1; 2014

Output kW	Motor type	Product code	Speed r/min	Efficiency IEC 60034-30-1; 2014			Power factor Cosφ	Current		Torque		Moment of inertia J = 1/4 GD <sup>2</sup> kgm <sup>2</sup>	Weight kg	Sound pressure Level L <sub>PA</sub> dB	
				Full load 100%	3/4 load 75%	1/2 load 50%		I <sub>N</sub> A	I <sub>s</sub> /I <sub>N</sub>	T <sub>N</sub> Nm	T <sub>f</sub> /T <sub>N</sub>				T <sub>b</sub> /T <sub>N</sub>
<b>1500 r/min = 4 poles</b>				<b>400 V 50 Hz</b>				<b>CENELEC-design</b>							
0.06	M2AA 56A 4	3GAA052001-...E	1390	52,8	49,6	40,8	0,54	0,3	3,2	0,41	3,2	3,3	0,00019	2,9	47
0.09	M2AA 56B 4	3GAA052002-...E	1400	56,2	52,6	44,8	0,59	0,39	3,1	0,62	2,3	2,8	0,00024	3,2	48
0.12	M2AA 63A 4	3GAA062001-...E	1360	55,0	51,3	43,0	0,64	0,49	3,2	0,84	2,4	2,5	0,00027	3,7	51
0.18	M2AA 63B 4	3GAA062002-...E	1370	63,5	61,0	54,3	0,61	0,67	3,7	1,25	2,8	2,9	0,00034	4,2	54
0.25	M2AA 71A 4	3GAA072001-...E	1365	65,1	66,0	62,7	0,76	0,72	4,0	1,74	2,0	2,1	0,00066	5,2	45
0.37	<sup>1)</sup> M2AA 71B 4	3GAA072002-...E	1375	69,7	71,9	71,1	0,79	0,96	3,8	2,5	2,0	2,2	0,0008	5,9	45
0.55	<sup>1)</sup> M2AA 80A 4	3GAA082001-...E	1375	72,8	76,1	75,2	0,77	1,41	4,5	3,8	1,8	2,2	0,0013	8,5	50
0.75	M2AA 80E 4	3GAA082215-...E	1425	79,8	80,4	77,9	0,72	1,88	6,6	5	3,5	3,6	0,002	15	54
1.1	M2AA 90LB 4	3GAA092214-...E	1435	83,7	84,1	83,0	0,78	2,4	6,6	7,3	2,9	3,2	0,0043	16	50
1.5	M2AA 90LD 4	3GAA092215-...E	1435	84,2	84,1	81,9	0,76	3,3	7,0	9,9	3,1	3,5	0,0048	17	50
2.2	M2AA 100LC 4	3GAA102213-...E	1450	86,4	86,2	84,1	0,79	4,6	7,3	14,4	2,8	3,4	0,009	25	54
3	M2AA 100LD 4	3GAA102214-...E	1445	85,7	86,1	85,1	0,79	6,3	7,0	19,8	2,4	3,0	0,011	28	63
4	M2AA 112MB 4	3GAA112212-...E	1445	86,7	86,5	85,2	0,75	8,8	7,3	26,4	3,1	3,4	0,0126	34	64
5.5	M2AA 132M 4	3GAA132212-...E	1465	89,0	89,5	88,6	0,79	10,9	6,3	36	1,9	2,6	0,038	48	66
7.5	M2AA 132MA 4	3GAA132214-...E	1460	89,1	89,9	89,5	0,79	15,3	6,4	49	1,8	2,6	0,048	59	63
11	M2AA 160MLA 4	3GAA162410-...F	1463	90,1	91,7	91,4	0,85	20,7	7,1	71,7	2,6	3,0	0,084	97	65
15	M2AA 160MLB 4	3GAA162420-...F	1463	90,6	92,1	91,9	0,84	28,4	7,2	97,9	2,7	3,6	0,095	105	65
18.5	M2AA 180MLA 4	3GAA182410-...F	1464	91,2	92,0	91,6	0,84	34,8	7,9	120	3,1	3,6	0,112	125	62
22	M2AA 180MLB 4	3GAA182420-...F	1465	91,6	92,2	91,8	0,83	41,7	8,0	143	3,0	3,8	0,13	137	65
30	M2AA 200MLA 4	3GAA202410-...F	1474	92,3	93,7	93,8	0,83	56,5	7,3	194	2,7	2,9	0,217	188	62
37	M2AA 225SMA 4	3GAA222210-...F	1478	93,0	93,9	93,8	0,84	68,6	7,2	238	2,6	2,9	0,309	239	68
45	M2AA 225SMB 4	3GAA222220-...F	1479	93,2	94,0	93,7	0,84	83,9	7,4	290	2,4	3,1	0,368	265	68
55	M2AA 250SMA 4	3GAA252210-...F	1478	93,5	94,3	93,8	0,85	99,1	7,3	355	2,8	3,0	0,476	311	70

<sup>1)</sup> Temperature rise class F

# Technical data

## IE2 aluminum motors 1000 r/min

IP 55 - IC 411 - Insulation class F, temperature rise class B  
IE2 efficiency class according to IEC 60034-30-1; 2014

Output kW	Motor type	Product code	Speed r/min	Efficiency IEC 60034-30-1; 2014			Power factor Cosφ	Current		Torque			Moment of inertia J = 1/4 GD <sup>2</sup> kgm <sup>2</sup>	Weight kg	Sound pressure Level L <sub>PA</sub> dB
				Full load 100%	3/4 load 75%	1/2 load 50%		I <sub>N</sub> A	I <sub>s</sub> /I <sub>N</sub>	T <sub>N</sub> Nm	T <sub>l</sub> /T <sub>N</sub>	T <sub>b</sub> /T <sub>N</sub>			
<b>1000 r/min = 6 poles</b>				<b>400 V 50 Hz</b>				<b>CENELEC-design</b>							
0.09	M2AA 63A 6	3GAA063001---E	890	50,7	48,5	42,0	0,62	0,41	2,8	0,96	2,0	2,2	0,00042	4,2	48
0.12	M2AA 63B 6	3GAA063002---E	890	52,3	48,8	41,5	0,60	0,55	3,0	1,29	2,2	2,4	0,00052	4,5	53
0.18	1) M2AA 71A 6	3GAA073001---E	885	59,5	61,1	56,5	0,71	0,61	3,1	1,94	1,7	1,9	0,00092	5,5	42
0.25	1) M2AA 71B 6	3GAA073002---E	895	64,0	63,6	59,5	0,71	0,79	3,3	2,6	2,2	2,2	0,0012	6,5	42
0.37	1) M2AA 80A 6	3GAA083001---E	905	68,0	70,7	68,3	0,73	1,07	3,6	3,9	1,6	2,1	0,002	9	47
0.55	M2AA 80B 6	3GAA083002---E	905	68,7	71,8	69,7	0,73	1,58	3,3	5,8	1,6	1,8	0,0026	10	47
0.75	M2AA 90LB 6	3GAA093213---E	930	77,6	76,2	75,6	0,71	1,96	4,0	7,7	2,0	2,3	0,0048	18	44
1.1	M2AA 90LD 6	3GAA093214---E	935	78,2	79,1	76,5	0,66	3	4,2	11,2	2,2	2,6	0,0056	20	44
1.5	M2AA 100LC 6	3GAA103212---E	945	80,3	81,4	80,7	0,73	3,6	3,9	15,1	1,7	2,0	0,009	26	49
2.2	M2AA 112MB 6	3GAA113212---E	955	81,9	81,8	79,2	0,72	5,3	5,2	21,9	1,8	2,2	0,01	28	56
3	M2AA 132S 6	3GAA133211---E	960	83,3	83,6	81,7	0,65	7,9	4,3	29,8	1,6	2,3	0,031	39	57
4	M2AA 132MB 6	3GAA133213---E	975	86,4	85,8	83,1	0,70	9,4	7,3	39,2	2,1	4,4	0,045	54	57
5.5	M2AA 132MC 6	3GAA133214---E	965	86,1	86,1	84,3	0,67	13,7	6,2	54,4	2,5	2,8	0,049	59	61
7.5	M2AA 160MLA 6	3GAA163410---F	971	87,6	88,8	88,7	0,79	15,6	7,1	73,7	1,9	3,3	0,089	105	61
11	M2AA 160MLB 6	3GAA163420---F	970	88,7	88,0	88,0	0,79	22,3	7,6	108	2,1	3,3	0,119	121	61
15	M2AA 180MLA 6	3GAA183410---F	971	89,7	90,9	90,6	0,76	31,7	7,8	147	2,5	4,1	0,137	139	61
18.5	M2AA 200MLA 6	3GAA203410---F	975	90,7	91,5	91,1	0,79	37,1	5,9	180,7	1,7	2,7	0,198	173	65
22	M2AA 200MLB 6	3GAA203420---F	974	91,0	91,8	91,7	0,79	44,1	5,8	215,6	1,8	2,6	0,222	184	65
30	M2AA 225SMA 6	3GAA223210---F	986	92,2	93,3	93,3	0,83	57,2	6,9	290	2,4	2,8	0,532	265	65
37	M2AA 250SMA 6	3GAA253210---F	985	92,3	93,3	93,0	0,82	70,4	6,6	358	2,4	2,8	0,718	305	66

<sup>1)</sup> Temperature rise class F

# Variant codes

## IE2 General performance aluminum motors

Variant codes specify additional options and features to the standard motor. The desired features are listed as three-digit variant codes in the motor order. Note also that there are variants that cannot be used together.

Code/Variants, M2AA	Frame size												
	56	63	71	80	90	100	112	132	160	180	200	225	250
<b>Bearings and Lubrication</b>													
037	-	-	-	-	-	-	-	-	•	•	•	•	•
040	-	-	•	•	•	•	•	•	-	-	-	-	-
041	-	-	-	-	-	-	-	-	•	•	•	•	•
043	-	-	-	-	•	•	•	•	•	•	•	•	•
188	-	-	-	-	•	○	○	•	•	•	•	•	•
<b>Branch standard designs</b>													
178	•	•	•	•	•	•	•	•	•	•	•	•	•
217	-	-	•	•	•	•	•	•	○	○	○	○	○
265	-	-	•	•	•	•	•	•	•	•	•	•	•
<b>Cooling system</b>													
053	-	-	•	•	•	•	•	•	-	-	-	-	-
068	-	-	•	•	•	•	•	•	•	•	•	•	•
<b>Documentation</b>													
141	•	•	•	•	•	•	•	•	•	•	•	•	•
<b>Drain holes</b>													
065	•	•	•	•	•	•	•	•	•	•	•	•	•
<b>Earthing Bolt</b>													
067	•	•	•	•	•	•	•	•	•	•	•	•	•
<b>Heating elements</b>													
450	•	•	•	•	•	•	•	•	•	•	•	•	•
451	•	•	•	•	•	•	•	•	•	•	•	•	•
<b>Marine</b>													
096	-	-	•	•	•	•	•	•	•	•	•	•	•
186	-	-	•	•	•	•	•	•	•	•	•	•	•
492	-	-	•	•	•	•	•	•	•	•	•	•	•
496	-	-	•	•	•	•	•	•	•	•	•	•	•
675	-	-	•	•	•	•	•	•	•	•	•	•	•
676	-	•	•	•	•	•	•	•	•	•	•	•	•
<b>Mounting arrangements</b>													
008	•	•	•	•	•	•	•	•	•	-	-	-	-
009	•	•	•	•	•	•	•	•	•	•	•	•	•
047	•	•	•	•	•	•	•	•	•	-	-	-	-
048	•	•	•	•	•	•	•	•	•	-	-	-	-
066	•	•	•	•	•	•	•	•	•	•	•	•	•
200	-	-	•	•	•	•	•	•	-	-	-	-	-
218	-	-	•	•	•	-	-	-	-	-	-	-	-
219	-	-	•	•	•	-	-	-	-	-	-	-	-
220	-	-	•	•	•	-	-	-	-	-	-	-	-
223	-	-	•	•	•	-	-	-	-	-	-	-	-
224	-	-	•	•	•	-	-	-	-	-	-	-	-
226	-	-	•	•	•	•	•	-	-	-	-	-	-

○ = Included as standard | • = Available as option | - = Not applicable

Code/Variants, M2AA	Frame size												
	56	63	71	80	90	100	112	132	160	180	200	225	250
227 Flange ring FT 130.	-	-	●	●	●	●	●	-	-	-	-	-	-
233 Flange ring FF 165.	-	-	-	●	●	●	●	-	-	-	-	-	-
234 Flange ring FT 165.	-	-	●	●	●	●	●	-	-	-	-	-	-
236 Flange FT 165.	-	-	-	-	-	-	-	●	-	-	-	-	-
243 Flange ring FF 215.	-	-	-	-	-	-	●	●	-	-	-	-	-
244 Flange ring FT 215.	-	-	-	-	-	-	-	●	-	-	-	-	-
253 Flange ring FF 265.	-	-	-	-	-	-	-	●	-	-	-	-	-
254 Flange ring FT 265.	-	-	-	-	-	-	-	●	-	-	-	-	-
255 Flange FF 265.	-	-	-	-	-	-	-	●	-	-	-	-	-
<b>Painting</b>													
114 Special paint color, standard grade	●	●	●	●	●	●	●	●	●	●	●	●	●
<b>Protection</b>													
005 Protective roof, vertical motor, shaft down.	●	●	●	●	●	●	●	●	●	●	●	●	●
072 Radial seal at D-end. Not possible for 2-pole, 280 and 315 frames	-	-	●	●	●	●	●	●	●	●	●	●	●
<b>Rating &amp; instruction plates</b>													
002 Restamping voltage, frequency and output, continuous duty.	●	●	●	●	●	●	●	●	●	●	●	●	●
095 Restamping output (maintained voltage, frequency), intermittent duty.	●	●	●	●	●	●	●	●	●	●	●	●	●
098 Stainless rating plate.	-	-	-	-	-	-	-	-	●	●	●	●	●
135 Mounting of additional identification plate, stainless.	-	-	●	●	●	●	●	●	●	●	●	●	●
159 Additional plate with text "Made in ...."	●	●	●	●	●	●	●	●	●	●	●	●	●
161 Additional rating plate delivered loose.	●	●	●	●	●	●	●	●	●	●	●	●	●
332 Baldor Catalogue #	●	●	●	●	-	-	-	-	-	-	-	-	-
<b>Standards and Regulations</b>													
331 IE1 motor not for sale for use in EU	-	-	-	●	●	●	●	●	●	●	●	●	●
540 China energy label	-	-	-	-	-	-	-	-	●	●	●	●	●
<b>Stator winding temperature sensors</b>													
122 Bimetal detectors, break type (NCC), (3 in series), 150 °C, in stator winding	●	●	●	●	●	●	●	●	●	●	●	●	●
435 PTC - thermistors (3 in series), 130 °C, in stator winding	●	●	●	●	●	●	●	●	●	●	●	●	●
436 PTC - thermistors (3 in series), 150 °C, in stator winding	●	●	●	●	●	●	●	●	○	○	○	○	○
441 PTC - thermistors (3 in series, 130 °C & 3 in series, 150 °C), in stator winding	-	-	-	-	●	●	●	●	●	●	●	●	●
445 Pt100 2-wire in stator winding, 1 per phase	-	-	-	-	-	-	-	-	●	●	●	●	●
<b>Terminal box</b>													
230 Standard metal cable gland.	●	●	●	●	●	●	●	●	●	●	●	●	●
375 Standard plastic cable gland	-	-	●	●	●	●	●	●	-	-	-	-	-
<b>Testing</b>													
145 Type test report from a catalogue motor, 400V 50Hz.	●	●	●	●	●	●	●	●	●	●	●	●	●
148 Routine test report.	●	●	●	●	●	●	●	●	●	●	●	●	●
<b>Variable speed drives</b>													
704 EMC cable entry.	●	●	●	●	●	●	●	●	●	●	●	●	●

○ = Included as standard | ● = Available as option | - = Not applicable

# Dimension drawings

## General performance aluminum motors

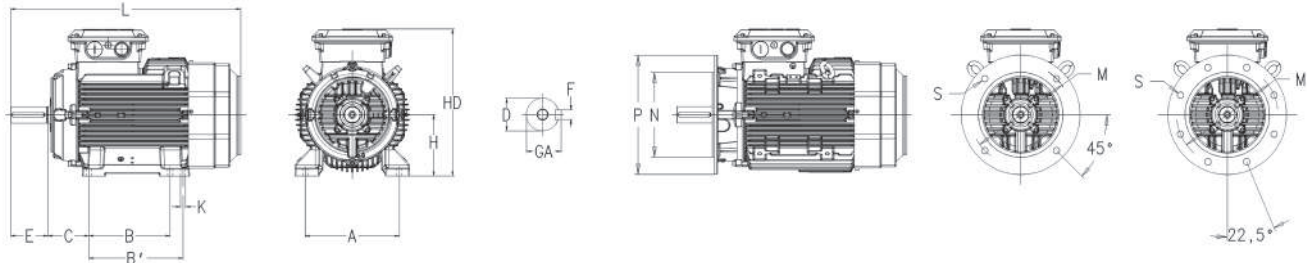

### Foot-mounted motor IM1001, B3 and flange-mounted motor IM3001, B5

Motor size	D poles		GA poles		F poles		E poles		L max poles		A	B	B'	C	HD	K	H	M	N	P	S
	2	4-6	2	4-6	2	4-6	2	4-6	2	4-6											
M2AA 56	9	9	102	102	3	3	20	20	196	196	90	71	-	36	152	5.8	56	100	80	120	7
63	11	11	125	125	4	4	23	23	220	220	100	80	-	40	170	7	63	115	95	140	10
71	14	14	16	16	5	5	30	30	240	240	112	90	-	45	180	7	71	130	110	160	10
80	19	19	215	215	6	6	40	40	2655	2655	125	100	-	50	193.5	10	80	165	130	200	12
90 S	24	24	27	27	8	8	50	50	2845	2845	140	100	-	56	217	10	90	165	130	200	12
90 L	24	24	27	27	8	8	50	50	3095	3095	140	125	-	56	217	10	90	165	130	200	12
100	28	28	31	31	8	8	60	60	351	351	160	140	-	63	237	12	100	215	180	250	15
112	28	28	31	31	8	8	60	60	393	393	190	140	-	70	249	12	112	215	180	250	15
132 <sup>1)</sup>	38	38	41	41	10	10	80	80	447	447	216	140	178	89	295.5	12	132	265	230	300	14.5
132 <sup>2)</sup>	38	38	41	41	10	10	80	80	487	487	216	140	178	89	321	15	132	265	230	300	14.5
160	42	42	45	45	12	12	110	110	584	584 <sup>3)</sup>	254	210	254	108	370	14.5	160	300	250	350	19
180	48	48	515	515	14	14	110	110	681	681	279	241	279	121	390	14.5	180	300	250	350	19
200	55	55	59	59	16	16	110	110	726	726	318	267	305	133	425	14.5	200	350	300	400	19
225	55	60	59	64	16	18	110	140	821	851	356	286	311	149	525 <sup>4)</sup>	18	225	400	350	450	19
250	60	65	64	69	18	18	140	140	880	880	406	311	349	168	572 <sup>4)</sup>	22	250	500	450	550	19

### Flange-mounted IM 3601, B14

Motor size	M	N	P	S	Tolerances	Footnotes
56	65	50	80	M5	A, B $\pm 0,8$	1) All types except M2A SC 2 pole, MC 6 pole
63	75	60	90	M5	D ISO j6 $\leq \varnothing 28$ mm	
71	85	70	105	M6	ISO k6 $< \varnothing 38$ mm	2) M2AA 132 SC 2 pole and MC 6 pole
80	100	80	120	M6	ISO m6 $\geq \varnothing 55$ mm	3) 160MLB 6-pole L = 681
90	115	95	140	M8	F ISO h9	4) For voltage code S add 32 mm
100	130	110	160	M8	H -0,5	to listed HD-dimension
112	130	110	160	M8	N ISO js6	5) 160MLB 6-pole L = 681
132 <sup>3)</sup>	165	130	200	M10	C $\pm 0,8$	6) 200, voltage code S HD = 478

# Motors in brief

## General performance aluminum motors, sizes 56 - 132

Size	M2AA	56	63	71	80	90	100	112	132	
Stator	Material	Die-cast aluminum alloy								
	Paint color shade	Munsell blue 8B 4.5/3.25 / NCS 4822 B05G								
	Surface treatment	Epoxy polyester powder paint, $\geq 60\mu\text{m}$				Polyester powder paint, $\geq 60\mu\text{m}$				
Feet	Material	Detachable aluminum feet		Integrated aluminum feet						
Bearing end shields	Material	Die-cast aluminum alloy								
	Paint color shade	Munsell blue 8B 4.5/3.25								
	Surface treatment	Epoxy polyester powder paint, $\geq 60\mu\text{m}$				Polyester powder paint, $\geq 60\mu\text{m}$				
Bearings	D-end	6201-2Z/C3	6201-2Z/C3	6203-2Z/C3	6204-2Z/C3	6205-2Z/C3	6306-2Z/C3	6306-2Z/C3	6208-2Z/C3 <sup>1)</sup>	
	N-end	6201-2Z/C3	6201-2Z/C3	6202-2C/C3	6203-2Z/C3	6204-2Z/C3	6205-2Z/C3	6205-2Z/C3	6206-2Z/C3	
Axially locked bearings	Inner bearing cover	ND-end internal retaining ring		D-end						
Bearing seals	D-end	V-ring								
	N-end	Labyrinth seal								
Lubrication		Permanently lubricated shielded bearings.								
Terminal box	Material	Die-cast aluminum alloy, base integrated with stator								
	Surface treatment	Die-cast aluminum alloy								
	Screws	Steel 5G, galvanised.								
Connections	Knock-out openings	1 x M16		2 x (M20 + M25) <sup>2)</sup>						
	Max Cu-area mm <sup>2</sup>	2.5	4	6	10 <sup>3)</sup>					
	Terminal box	Cable lugs, 6 terminals								
Fan	Material	Polypropylene. Reinforced with 20% glass fibre.								
Fan cover	Material	Steel			Polypropylene					
Stator winding	Material	Copper								
	Insulation	Insulation class F								
	Winding protection	Optional								
Rotor winding	Material	Die-cast aluminum								
Balancing method		Half-key balancing								
Key ways		Closed key way								
Heating elements	Optional	8 W	25 W							
Enclosure		IP 55								
Cooling method		IC 411								
Drain holes		Without drainholes			Drain holes with closable plastic plugs, open on delivery.					
Lifting lugs		Without lifting lugs			Integrated with the stator					



# Motors in brief

## General performance aluminum motors, sizes 160 - 250

Size	M2AA	160	180	200	225	250
Stator	Material	Die-cast aluminum alloy			Extruded aluminum alloy	
	Paint colour shade	Munsell blue 8B 4.5/3.25				
	Surface treatment	Polyester powder paint, $\geq 60\mu\text{m}$				
Feet		Detachable feet				
	Material	Aluminum alloy			Cast iron	
Bearing end shields	Material	Cast iron EN-GJL-200/GG 20/GRS 200				
	Paint colour shade	Munsell blue 8B 4.5/3.25 / NCS 4822 B05G				
	Surface treatment	Two-pack epoxy pain paint, $\geq 60\mu\text{m}$				
Bearings	D-end	6209-2Z/C3	6210-2Z/C3	6212-2Z/C3	6213-2Z/C3	6215-2Z/C3
	N-end	6209-2Z/C3	6209-2Z/C3	6209-2Z/C3	6210-2Z/C3	6212-2Z/C3
Axially-locked	Inner bearing cover	D-end				
Bearing seals		Axial seal				
Lubrication		Permanently lubricated shielded bearings.				
Terminal box	Material	Die-cast aluminum alloy, base integrated with stator.			Deep-drawn steel sheet, bolted to stator.	
	Surface treatment	Polyester powder paint, $\geq 60\mu\text{m}$			Phosphated. Polyester paint.	
	Screws	Steel 8.8, zinc electroplated and chromated				
Connections	Knock-out openings				2 x FL13, 2 x M40	
	Flange openings	(2 x M40 + M16) + (2 x M40)			2 x FL 21, 2 x M63 (voltage code S)	
	Max Cu-area mm <sup>2</sup>	35			70	
	Terminal box	6 terminals for connection with cable lugs (not included)				
	Screws	M6			M10	
Fan	Material	Polypropene. Reinforced with 20% glass fibre.				
Fan cover	Material	Hot dip galvanized steel				
	Paint colour shade	Black, NCS 8801-B09G				
	Surface treatment	Polyester powder paint, $\geq 60\mu\text{m}$				
Stator winding	Material	Copper				
	Insulation class	Insulation class F				
	Winding protection	3 PTC thremistors as standard, 150°C				
Rotor winding	Material	Diecast aluminum				
Balancing method		Half key balancing				
Key Ways		Closed key way				
Heating elements	Optional	25 W		50W		
Enclosure		IP 55				
Cooling method		IC 411				
Drain holes		Drain holes with closable plastic plugs, open on delivery.				
Lifting lugs		Integrated with the stator			Bolted to the stator	

# Total product offering

Motors, generators and mechanical power transmission products with a complete portfolio of services



## IEC motors

- Low voltage motors
- High voltage induction and synchronous motors
- Marine motors
- Motors for explosive atmospheres
- Motors for food and beverage
- Motors for variable speed drives
- Permanent magnet motors
- Synchronous reluctance motors
- Traction motors

## NEMA motors

- Low voltage motors
- High voltage induction and synchronous motors
- Marine motors
- Motors for explosive atmospheres
- Motors for variable speed drives
- Permanent magnet motors
- Servomotors
- Washdown motors

## Generators

- Generators for wind turbines
- Generators for diesel and gas engine power plants
- Generators for steam and gas turbine power plants
- Generators for marine applications
- Generators for industrial applications
- Generators for traction applications
- Synchronous condensers for reactive power compensation

## Mechanical power transmission components, bearings, gearings

- Mounted bearings
- Enclosed gearing
- Mechanical drive components
- Couplings
- Sheaves and bushings
- Conveyor components
- Geared motor units

## Life cycle services

# ABB's portfolio of drives

## Optimal solution for you



Being able to rely on the continuous high performance and efficiency of your operations is something you want to take for granted. ABB variable-frequency drives are made with all this in mind, established upon more than 40 years of experience and backed by a broad range of life cycle services.

ABB drives help you to optimize your processes and systems with state-of-the-art motor control technology, resulting in increased energy efficiency, better product quality, and reduced operating costs with higher output, less downtime, and reduced need for maintenance. All ABB drives are designed for easy selection, ordering, installation and use, and they offer integrated safety features, giving you more time to focus on what matters for you and your business.

Our portfolio offers low-voltage AC and DC drives, medium-voltage AC drives, and motion control drives spanning the fractional-kilowatt to multi-megawatt power level. There is a drive available for essentially every industry and application, which can be used with all types of motors, in environments ranging from clean electrical rooms in buildings, to harsh coal mines and windy offshore platforms. This wide product range allows you to select the best-fitting drive solution, providing maximum reliability and efficiency for every need.

# Contact us



---

For more information and contact details:

[www.abb.com/motors&generators](http://www.abb.com/motors&generators)